

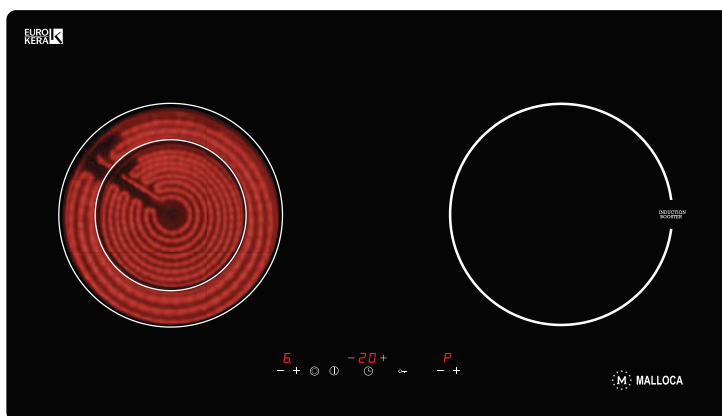

Operating and Installation Instructions



Induction hobs:

**MDH-02I, MH-20I, MH-02I D, MH-02I PG, MH-02I SB,
MH-02I TB, MH-03I, MH-04I**

Combined hobs:

**MH-02IR, MH-02IR D, MH-02IR PG, MH-02IR SB,
MH-02IR TB, MH-03IRA, MH-03IRB, MH-03IRB S,
MH-03IRB LB, MH-03IRB DB, MH-03IRB BR,
MH-04IR, MH-04IR S**

To avoid the risk of accidents or damage to the appliance it is essential to read these instructions before it is installed and used for the first time.

Important Safety Instructions	05
Cleaning and Care	12
Appliance errors	13
Safety Instructions for Installation	14
Caring for the environment	16
Before using for the first time	17
MDH-02I	
Guide to the hob	20
MH-02I, MH-02I D, MH-02I PG, MH-02I SB, MH-02I TB	
Guide to the hob	23
MH-03I	
Guide to the hob	26
MH-04I	
Guide to the hob	29
MH-02IR, MH-02IR D, MH-02IR PG, MH-02IR SB, MH-02IR TB	
Guide to the hob	32
MH-03IRA	
Guide to the hob	35
MH-03IRB, MH-03IRB S, MH-03IRB LB, MH-03IRB DB, MH-03IRB BR	
Guide to the hob	38
MH-04IR & MH-04IR S	
Guide to the hob	40
INDUCTION	
How induction works	44
Noises	45
Suitable pans	47
Use	48
Safety Features	52

Contents

RADIANT

How the cooking zone works.....	56
Suitable pans.....	57
Tips on saving energy.....	58
Use.....	59
Safety features.....	63
Installation	66
Electrical Connection.....	67

Important Safety Instructions

READ THE OPERATING INSTRUCTIONS CAREFULLY BEFORE USING THE HOB

Warning

This hob is intended for residential cooking only. Malloca cannot be held responsible for damage or injury caused by improper use or for uses other than those for which this hob is intended.

When using your hob follow basic safety precautions including the following:

Installation

Be certain your hob is properly installed and grounded by a qualified technician in accordance with national and local safety regulations. Malloca cannot be held responsible for damage caused by incorrect installation or connection.

Do not connect the hob to the main electrical supply using an extension cord. Extension cords do not meet the safety requirements of this hob.

Before servicing, disconnect the hob from the main power supply.

To guarantee the electrical safety of this hob, continuity must exist between the hob and an effective grounding system. It is imperative that this basic safety requirement be met. If there is any doubt, have the electrical system of the house checked by a qualified electrician. Malloca will not be held responsible for damages caused by the lack, or inadequacy, of an effective grounding system.

Important Safety Instructions

Use

Only use the hob for residential cooking, and for the purposes described in this manual.

Other uses are not permitted and can be dangerous. Malloca will not be held liable for damage caused by unauthorized use or improper operation of any kind.

Persons who lack physical, sensory or mental abilities, or experience with the hob should not use it without supervision or instruction by a responsible person.

Individuals with a pacemaker or similar medical device: Please note that an electromagnetic field develops when the hob is turned on. Although unlikely that this will affect a pacemaker or other medical device please consult the device manufacturer or your doctor if you have concerns.

Keep magnetized items, e.g. credit cards, disks, etc. away from the hob while in operation. Damage may result.

Do not use the hob until it has been properly installed in the countertop.

This hob is equipped with an overheating protection feature. See “Over heating protection” for more information.

Be sure to use the proper type of cookware. Follow the manufacturer’s instructions.

If the hob is installed above a pyrolytic oven it should not be used during the pyrolytic process. The overheating protection feature of the hob might be activated.

Important Safety Instructions

Injury prevention

Children should not be left unattended in an area where the hob is in use. Never allow children to sit or stand on any part of the hob.

Caution: *Do not store items of interest to children in cabinets above the hob. Children climbing on the hob to reach these items could be injured.*

Use the Child Safety Lock to prevent children from turning on the heaters or changing the settings. See “Child Safety lock” for more information.

Keep all pots and pans out of children’s reach. Danger of burning or scalding.

Do not touch the hob or the surrounding areas during or immediately after use. The hob may be hot even though it is dark in color. Wait until the residual heat indicators go out.

Protect your hands with insulated gloves or potholders when using the hob. Use only dry, heat resistant potholders. Moist or damp potholders used on hot surfaces can result in steam burns. Do not let the potholder touch the hot heating elements. Do not use towels or other bulky items near the hob.

Be aware of loose fitting or hanging clothing when operating the hob, they may present a fire hazard.

Pot and pan handles should be turned inward and not extend over the countertop to reduce the risk of burns, ignition of flammable materials, and spills.

Never leave a hob unattended at high settings or when cooking with oil or fat. Overheated oil could ignite. Always heat oil slowly, monitoring it as it heats.

Do not use water on grease fires. Smother or use a dry chemical or foam-type extinguisher on any fire or flame.

When frying food make sure that the food is as dry as possible before placing it in oil. Moisture can cause hot oil to splatter and boil over. At high settings, be cautious of splattering grease or boiling over liquids which may produce smoke.

Do not flambé under an exhaust hood. Flames could be drawn up into the hood by the suction and the grease filters may ignite.

Important Safety Instructions

Do not heat unopened containers. Built-up pressure may cause the container to burst and result in injury.

Before removing pots and pans be sure to turn off the heaters.

To prevent burns and breathing difficulty, allow the hob to cool before cleaning. Some cleaners may produce toxic fumes if applied to a hot surface.

When wiping spills on a hot hob with a wet sponge or cloth, be careful to avoid steam burns.

Do not let flammable materials, i.e. cooking grease, accumulate on the hob.

Never cover the hob with a cloth. A fire may result.

Do not place items other than pots and pans on the hob.

Flammable materials should not be stored on or near the hob.

The hob is fitted with a cooling fan. Drawers under the hob are not recommended. If a drawer is fitted directly underneath the hob, ensure that there is sufficient space between the drawer, its contents and the underside of the appliance in order to ensure sufficient ventilation for the hob.

Do not store small items or paper in the drawer. They could get sucked into the housing by the fan and cause damage or impair cooling. Ensure that no aerosols, combustible liquids or other flammable materials are kept in this drawer. If cutlery inserts are to be placed in the drawer they must be made of heat-resistant material.

Damage protection

Never place hot pots or pans on the touch controls, this may damage the electronics.

Do not drop anything on the ceramic surface of the hob. Even lightweight objects may cause damage.

Do not use pots or pans with pronounced edges or ridges on the ceramic hob. These could scratch the hob permanently. See “Cookware” for more information. Grains of salt and sand can cause scratches. Make sure that the bases of any pots and pans are clean, free of any fat or oils, and are dry.

Do not allow solid or liquid sugar, pieces of plastic or foil to fall on the heaters when they are hot. If these residues are allowed to cool on the ceramic surface pitting or even cracking may occur.

Any spills should be removed as quickly as possible to prevent them from burning on and becoming difficult to remove.

Do not use a steam cleaner to clean this hob. Steam could penetrate electrical components and cause a short circuit.

Important Safety Instructions

Appliance safety

In the event of any damage to the hob, it must be turned off immediately and disconnected from the main power supply. Contact Malloca's Technical Service Department.

Do not use the hob until it has been repaired. Ensure power is not supplied to the hob until repair work is completed.

Do not cook on a damaged hob. Any breakages or cracks in the ceramic surface of the hob are defects and must be treated as such. If the hob should break, cleaning solutions and spills may penetrate the broken hob and create a risk of electric shock. Do not use the hob until it has been repaired.

Repairs should only be performed by qualified technicians to ensure safety. Repairs and other work by unqualified persons could be dangerous. Do not open the outer casing of the hob under any circumstances.

While the hob is under warranty repairs should only be performed by an authorized service technician. Otherwise the warranty is void.

Further safety notes

Make certain that the power cords of small appliances do not come in contact with the hob. The insulation of the cable could become damaged.
Danger of electric shock!

Keep pets away from the hob at all times and activate the Child Safety Lock. If a pet gets on the hob a touch control sensor could be activated turning on a heater.

Important Safety Instructions

To eliminate the risk of burns or fire by reaching over heated surfaces cabinet storage space above the hob should be avoided. If cabinet storage is necessary, the risk can be reduced by installing a venting hood to project horizontally a minimum of 127mm beyond the bottom of the cabinets.

Because of the heat radiated it is not recommended to install the hob above a drawer. It should be installed above a cabinet base unit with a dummy drawer front. A protective base should also be installed between the dummy drawer and the hob. There must be a minimum distance of 110 mm between the top of the countertop and the top of the protective base to ensure proper ventilation.

This hob has not been designed for maritime use or for use in mobile installations such as recreational vehicles or aircraft. However, under certain conditions it may be possible for installation in these applications. Please contact the Malloca Technical Service Department with specific requirements.

The hob must not be permanently sealed into the countertop when installed. The sealing strip under the edge of the hob provides a sufficient seal for the countertop.

Once installed, be sure that the power cord cannot come into contact with the underside of the hob or any mechanical parts.

Cleaning and Care

Do not use a steam cleaner to clean this hob. Steam could penetrate electrical components and cause a short circuit. Pressurized steam could cause permanent damage to the surface and to components for which Malloca cannot accept responsibility.

Do not use any sharp pointed objects which could damage the seal between the ceramic surface, the surrounding frame and the countertop.

Never use abrasive or caustic (oven) cleaners, dishwasher detergent, scouring pads, steel wool or hard brushes. They will damage the surface.

The ceramic surface can be cleaned using a cleaner for ceramic surfaces. Follow the manufacturer's instructions.

Make sure that no cleaner residue remains on the ceramic surface by carefully wiping the hob with a damp cloth. They may damage the hob or produce toxic fumes when heated.

Be sure that pot and pan bases are clean and dry.

After cleaning, dry the ceramic surface with a soft cloth to prevent a build up of limescale deposits.

Clean any spills immediately before they become difficult to remove. Clean the hob regularly, preferably after each use. Allow the hob to cool before cleaning.

Wipe off any soiling using a damp cloth. Stubborn soiling is best removed with a shielded scraper blade.

Apply a ceramic cleaner using a soft cloth or paper towel. To remove any lime-scale deposits or metallic residue apply a ceramic cleaner using a soft cloth and a shielded scraper blade if necessary.

After cleaning wipe the ceramic surface with a damp cloth and dry. A cleaner with a special additive to prevent water marks and smears on the ceramic surface may be used.

Any melted solids like sugar, plastic or aluminum foil should be removed as soon as possible, while the heater is still warm. If they are allowed to harden the hob may become pitted.

Appliance errors

Appliance errors are the errors which generate the deactivation of the whole hob.

When an appliance error is detected, all heaters are switched off, a beep sounds (only if one or more heaters are active) and all displays show a 'F' letter and the error code alternately.

While in error status all the heater keys are not operative .

Except EEPROM and microcontroller errors, all errors are recoverable. That is, when the cause of the error disappears all displays are deactivated and the hob returns to normal operation.

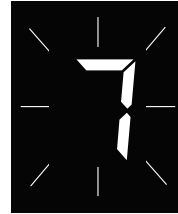
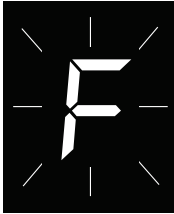

Appliance errors			
Error (Visualization Priority Order)	Error recovery	Action	All Heater Displays (fore 0.5 sec./ back 0.5 sec)
Microcontroller fault	-----	App. off	F0
On/Off key emitter fault	When the fault disappears	App. off	FA
On/Off key receiver fault	When the fault disappears	App. off	FC
User interface temperature sensor short-circuit	When the fault disappears	App. off	FE
User interface temperature sensor open-circuit	When the fault disappears	App. off	Ft
User interface overtemperature	When user interface temperature < 90°C	App. off	Fc
EEPROM fault	-----	App. off	FH
Microcontroller A/D converter multiplexer fault	When the fault disappears	App. off	FJ
Ambient Light fault	When satisfactory ambient lighting is detected	App. off	FL
Microcontroller A/D converter conversion fault	When the fault disappears	App. off	FU

Safety Instructions for installation

Safety distance above the hob

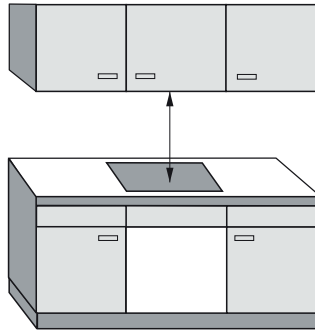

The minimum safety distance given by the hood manufacturer must be maintained between the hob and the hood above it. See the installation instructions of the hood for these safety measurements.

If the hood manufacturers instructions are not available or if flammable objects are installed over the hob (e.g. cabinets, utensil rail, etc.), a minimum safety distance of (760 mm) must be maintained.

If there is more than one appliance beneath a hood (e.g. wok burner and electric cooktop), and they have different minimum safety distances always observe the greater distance.

Ventilation

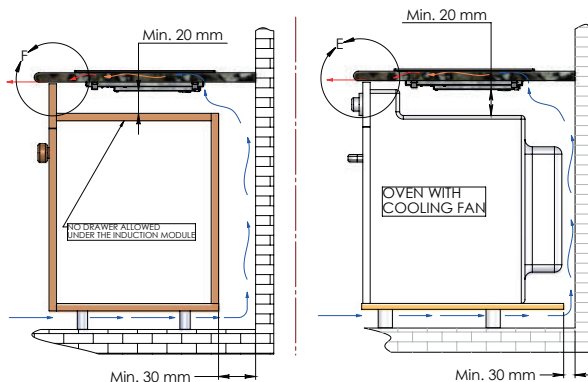

Safety Instructions for installation

Installation

Feed the hob connection cable down through the cut-out.

Place the hob centrally in the cut-out. When doing so make sure that the seal under the cooktop sits flush with the countertop on all sides. This is important to ensure an effective seal. (*Do not use sealant*).

Connect the hob to the main power supply.

Turn the hob on and check the function.

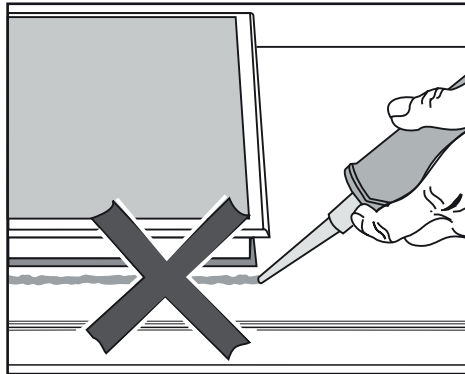

The hob must not be permanently sealed into the countertop when installed. The sealing strip under the edge of the hob provides a sufficient seal for the countertop.

If the hob is sealed into position, the countertop or appliance could be damaged if the hob needs to be removed for maintenance or service.

Caring for the environment

Disposal of the packing material

The transport and protective packing has been selected from materials which are environmentally friendly for disposal and should be recycled.

Ensure that any plastic wrappings, bags, etc. are disposed of safely and kept out of the reach of babies and young children. Danger of suffocation.

Disposal of your old appliance

Electrical and electronic appliances often contain materials which, if handled or disposed of incorrectly could be potentially hazardous to human health and to the environment. They are, however, essential for the correct functioning of your appliance. Please do not therefore dispose of it with your household waste.

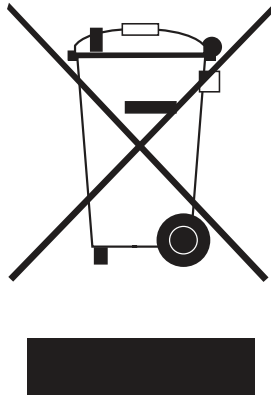

Please dispose of it at your local community waste collection/recycling centre or contact your dealer for advice. Ensure that it presents no danger to children while being stored for disposal.

Cleaning the hob

Before using for the first time, clean the hob with a damp cloth and dry with a soft cloth.

Heating the hob

Metal components of the hob have a protective coating which may give off a slight odor the first time the hob is heated.

The smell will dissipate after a short time and does not indicate a faulty connection or appliance defect.

Before using for the first time

Touch controls

The control panel is equipped with Infrared sensor. They respond to a finger touch.

To operate the heaters, simply touch the corresponding sensor area(s). Each time a command is registered, a signal will be heard.

Be sure to touch only the desired sensor area and keep the control panel clean and clear. Otherwise, the touch controls may not respond, or unintentional commands may be given, even causing the cooktop to switch off automatically (see “Automatic Safety off”).

User interface initial calibration

The user interface has implemented an initial keyboard calibration focused to adapt the sensibility of the keys, to the final mechanical, environmental and user conditions.

Anytime the Cooktop is plugged or there is a power failure that generates a reset in the user interface, the first time the Key lock is touched the sensitivity of the keyboard is readjusted. This first touch of the Key Lock must be done in certain conditions:

Do not use gloves

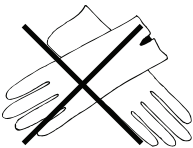

Use a clean finger



Touch the glass (smooth touching)

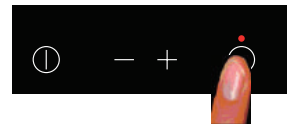

Initial Light Conditions

When power is initially applied to the Cooktop, the touch control conducts a calibration process for the touch keys, which requires a low level of ambient light in the area of the touch keys.

If during this calibration process excessive ambient lighting is detected the User Interface displays “FL” (Infrared Ambient Light Error) and the control calibration process is suspended.

In order to rectify the process any lighting that could affect the calibration process should be switched off (e.g. halogen cooker hood lighting).

The error will disappear when satisfactory ambient lighting is detected and the touch control calibration procedure will now complete satisfactorily.

Notes:

- 1) The “FL” error can only be generated within approx. 3s of initial power being applied to the cooktop.
- 2) We recommend that you switches off all cooker hood lighting and lighting directed towards the Cooktop when power is initially applied to the Cooktop.
- 3) After the touch control has conducted its initial calibration process, (approx. 3s) any cooker hood or other lighting can be switched on as normal and will not affect the operation of the touch control

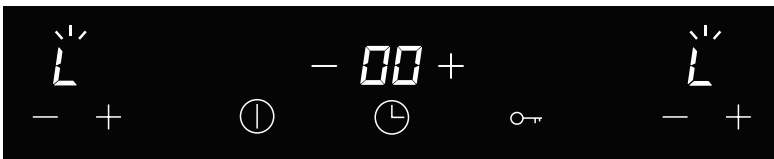
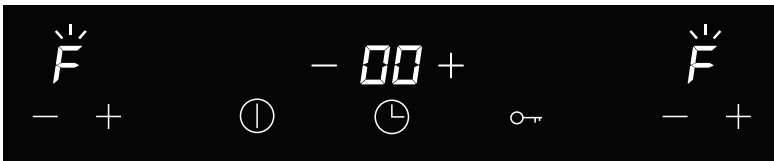

Guide to the hob

MDH-02I

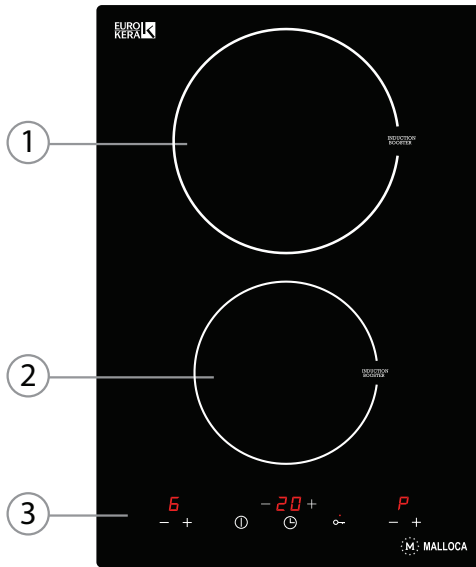

- ① ②
- ③

Heaters
Control panel

Control panel

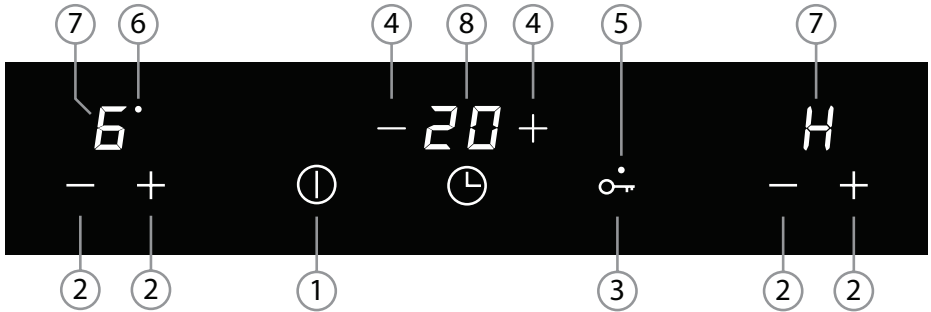

Sensors for

- ① Turning the hob on and off
- ② Setting the power level
- ③ Child safety lock
- ④ Setting the timer

Indicator lamps



- ⑤ Child safety lock
- ⑥ Timer

Display

- ⑦ Power level, residual heat display
- ⑧ Timer display

Guide to the hob

Heater data

Heater \varnothing in mm	Power Level	Rating in W 220-240V	
		215	156
 215	1	100	75
	2	200	150
	3	300	300
	4	500	400
	5	700	500
 156	6	900	600
	7	1100	800
	8	1300	1000
	9	1500	1200
	Booster "P"	2000	1600

MH-02I, MH-02I D, MH-02I PG, MH-02I SB, MH-02I TB

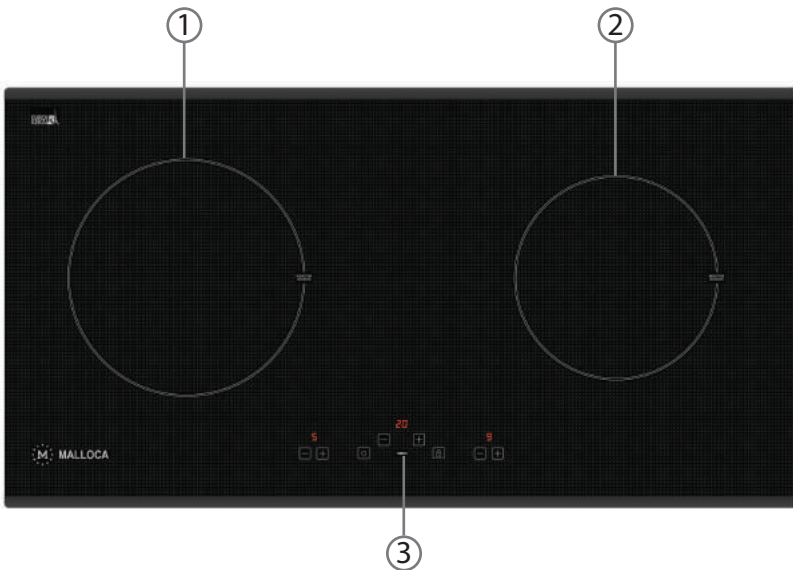
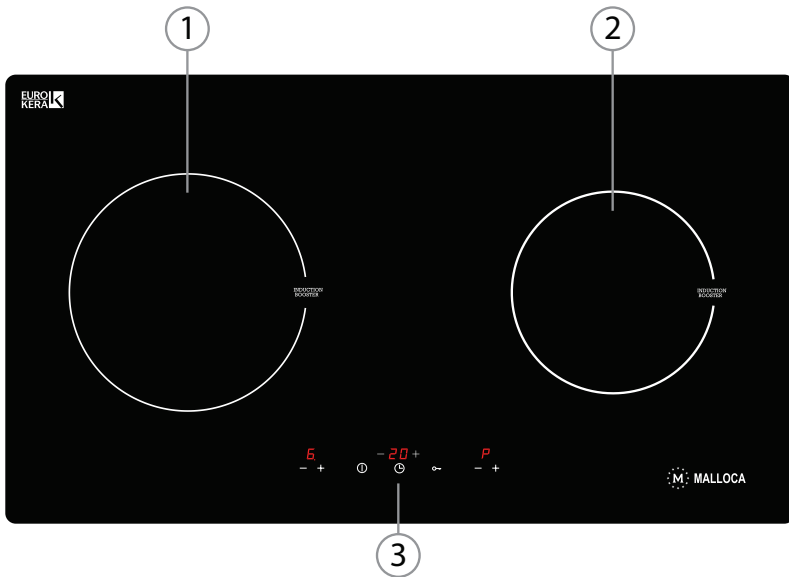

- ① ② Heaters
- ③ Control panel

Guide to the hob

Control panel

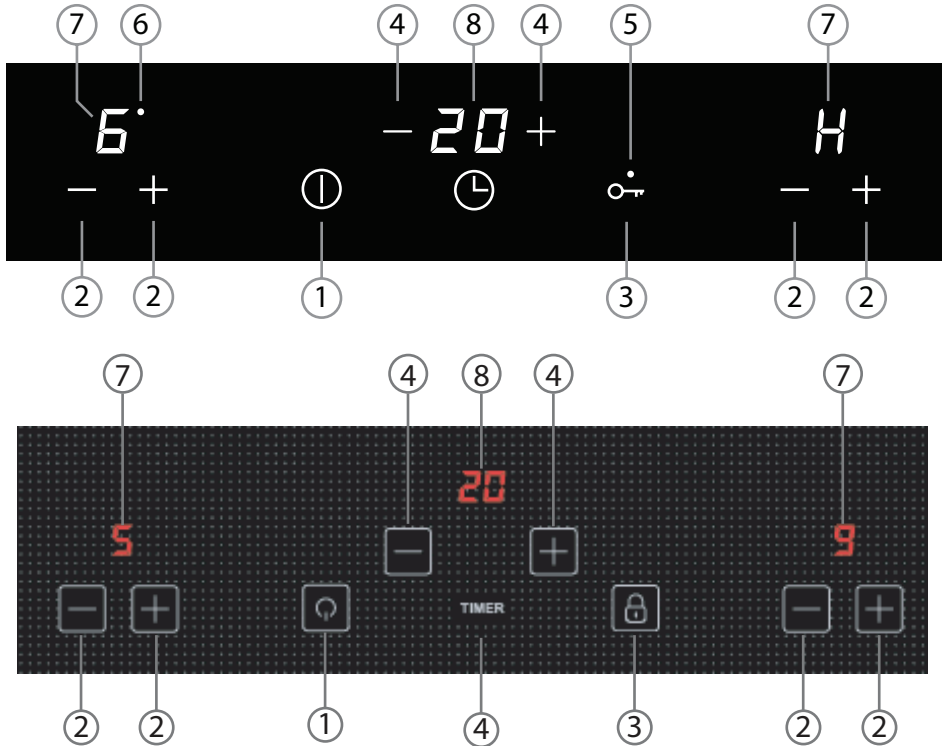

Sensors for

- ① Turning the hob on and off
- ② Setting the power level
- ③ Child safety lock
- ④ Setting the timer

Indicator lamps

- ⑤ Child safety lock
- ⑥ Timer

Display

- ⑦ Power level, residual heat display
- ⑧ Timer display

Heater data

Heater \varnothing in mm	Power Level	Rating in W 220-240V	
		215	185
<div style="display: flex; align-items: center; gap: 10px;"> <div style="border: 1px solid black; width: 20px; height: 20px; display: flex; align-items: center; justify-content: center;">●</div> 215 </div>	1	100	100
	2	200	200
	3	300	300
	4	500	500
	5	700	700
<div style="display: flex; align-items: center; gap: 10px;"> <div style="border: 1px solid black; width: 20px; height: 20px; display: flex; align-items: center; justify-content: center;">●</div> 185 </div>	6	900	900
	7	1100	1000
	8	1300	1200
	9	1500	1400
	Booster "P"	2000	1800

Guide to the hob

MH-03I

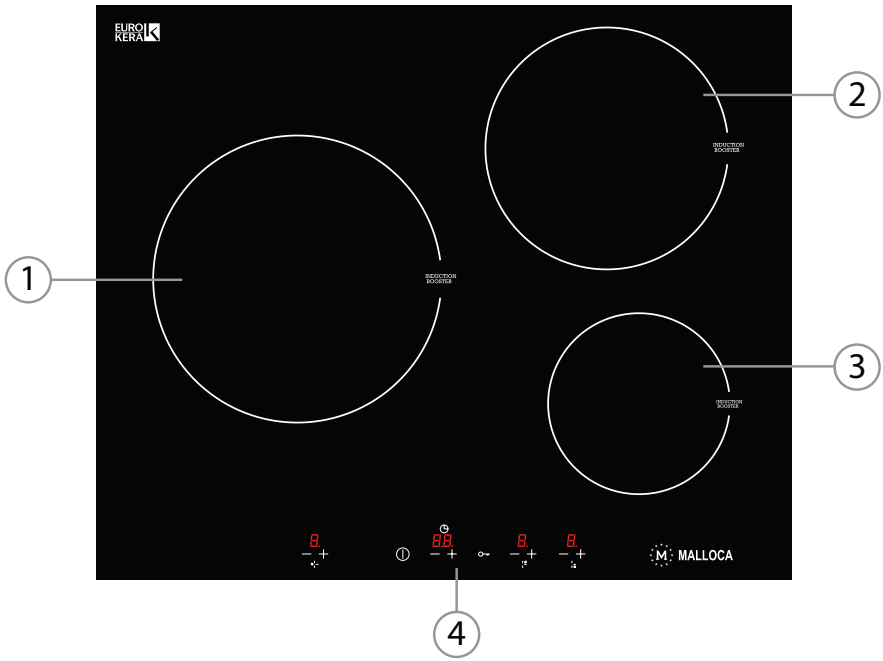

- ① ② ③ Heaters
- ④ Control panel

Control panel

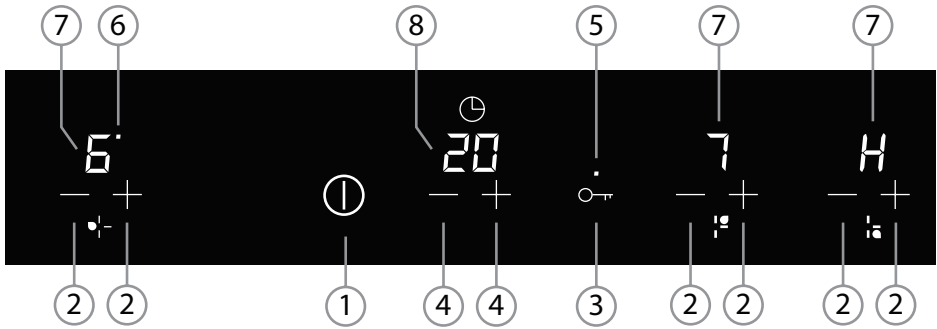

Sensors for

- Turning the hob on and off
- Setting the power level
- Child safety lock
- Setting the timer

Indicator lamps

- Child safety lock
- Timer

Display

- Power level, residual heat display
- Timer display

Guide to the hob

Heater data

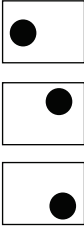
Heater \varnothing in mm	Power level	Rating in W 230-240V		
		240	215	150
 240 215 150	1	100	100	75
	2	200	200	150
	3	300	300	300
	4	500	500	400
	5	700	700	500
	6	900	900	600
	7	1200	1100	800
	8	1400	1300	1000
	9	1600	1500	1200
	Booster "P"	2200	2000	1600

MH-04I

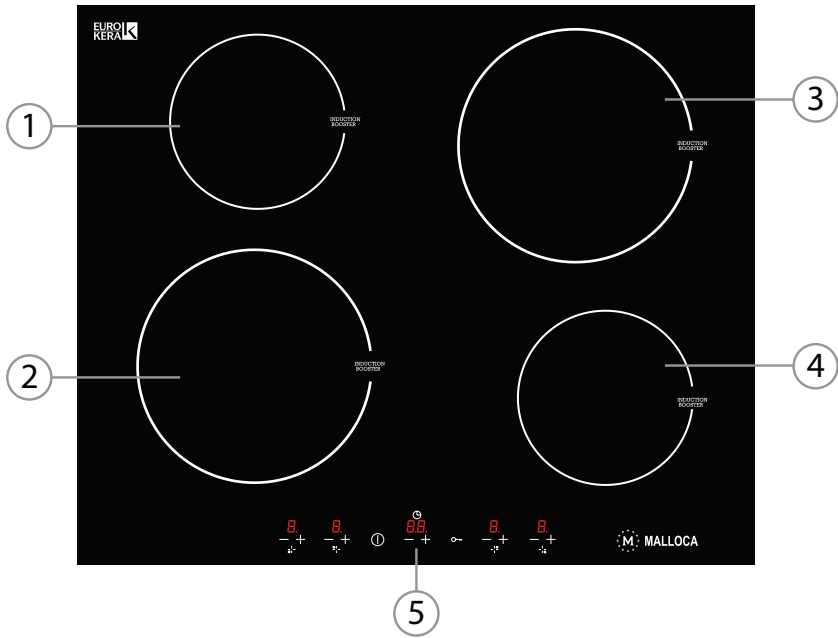

- ①
- ②
- ③
- ④
- ⑤

Heaters
Control panel

Guide to the hob

Control panel

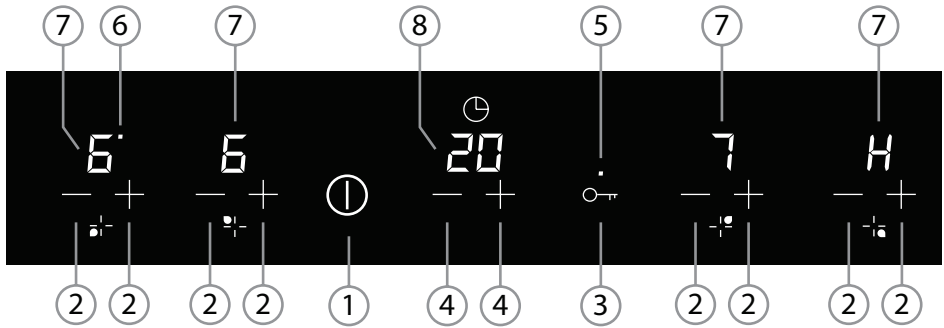

Sensors for

- ① Turning the hob on and off
- ② Setting the power level
- ③ Child safety lock
- ④ Setting the timer



Indicator lamps

- ⑤ Child safety lock
- ⑥ Timer

Display

- ⑦ Power level, residual heat display
- ⑧ Timer display

Heater data

Heater \varnothing in mm	Power level	Rating in W 230-240V	
		215	150
 215  150	1	100	75
	2	200	150
	3	300	300
	4	500	400
	5	700	500
	6	900	600
	7	1100	800
	8	1300	1000
	9	1500	1200
	Booster "P"	2000	1600

Guide to the hob

MH-02IR, MH-02IR D, MH-02IR PG, MH-02IR SB, MH-02IR TB

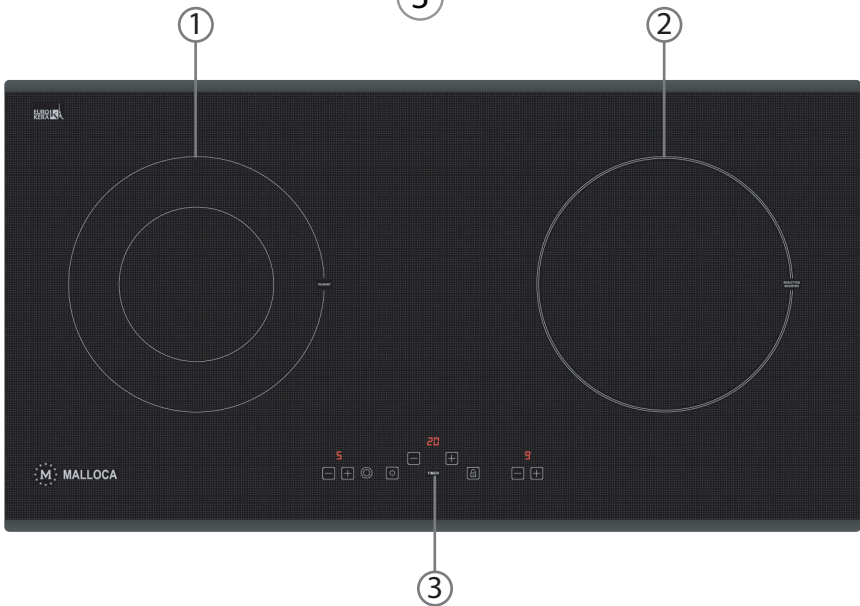
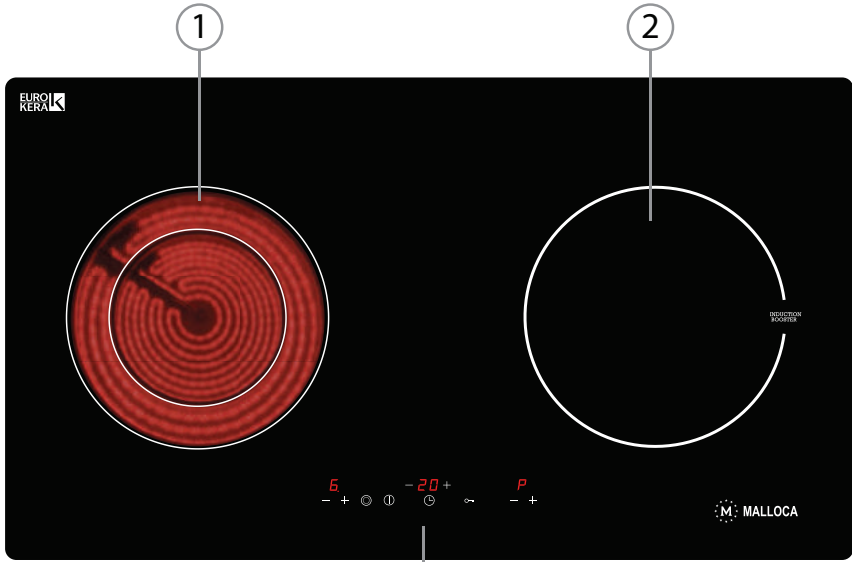

- ① Radiant heater
- ② Induction heater
- ③ Control panel

Control panel

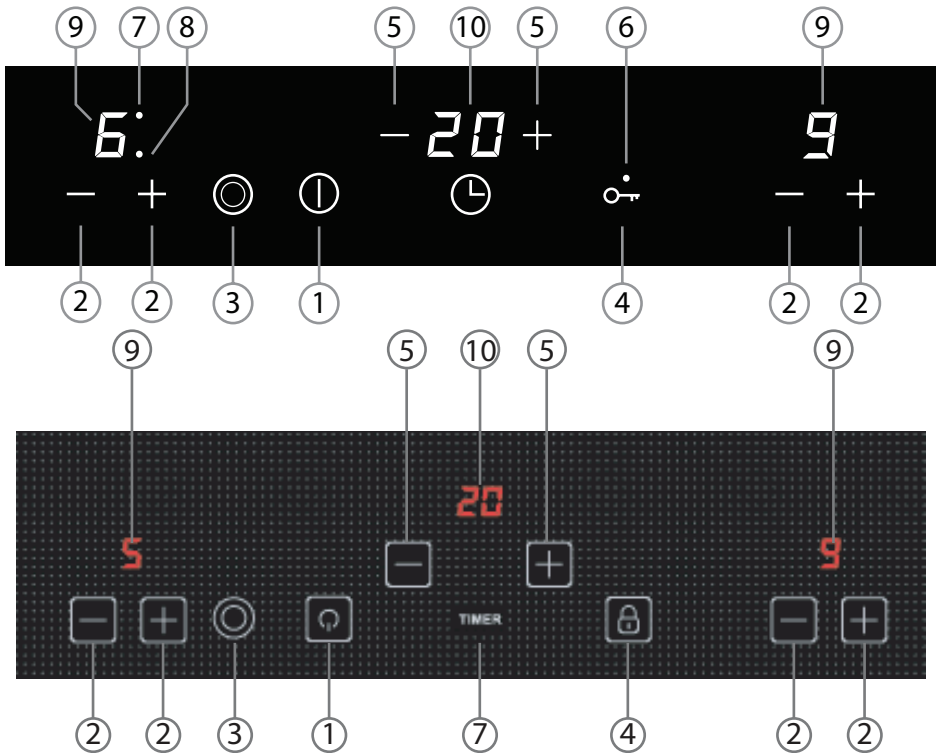

Sensors for

- ① Turning the hob on and off
- ② Setting the power level
- ③ Turning double zone on and off
- ④ Child safety lock
- ⑤ Setting the timer

Indicator lamps

- ⑥ Child safety lock
- ⑦ Timer
- ⑧ Heat-up

Display

- ⑨ Power level, residual heat display
- ⑩ Timer display

Guide to the hob

Heater data

Heater Ø in mm	Power level	Rating in W 220-240V		
		Radiant Single	Radiant Double	Induction
 215	1	24	57	100
	2	48	114	200
	3	112	266	300
	4	144	342	500
	5	200	475	700
 215	6	248	589	900
	7	360	855	1100
	8	512	1216	1300
	9	800	1900	1500
	Booster "P"			2000

MH-03IRA

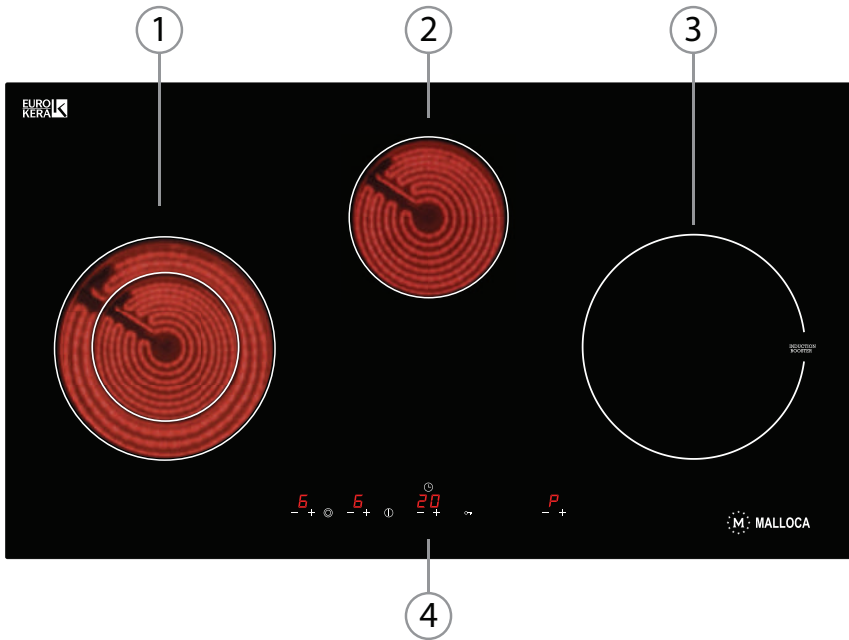

- ① ② Radiant heaters
- ③ Induction heater
- ④ Control panel

Guide to the hob

Control panel

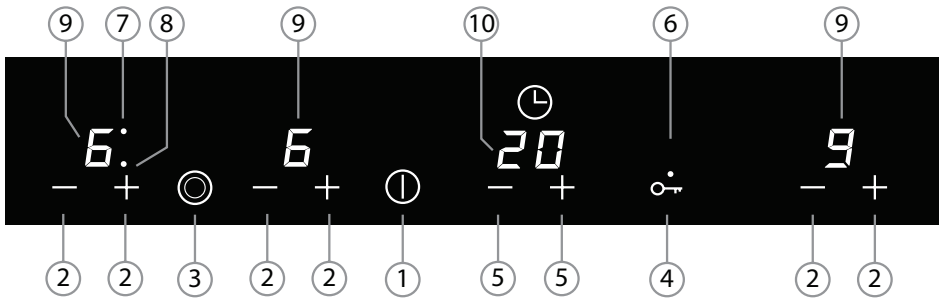

Sensors for

- ① Turning the hob on and off
- ② Setting the power level
- ③ Turning double zone on and off
- ④ Child safety lock
- ⑤ Setting the timer



Indicator lamps

- ⑥ Child safety lock
- ⑦ Timer
- ⑧ Heat-up

Display

- ⑨ Power level, residual heat display
- ⑩ Timer display

Heater data

Heater Ø in mm		Power level	Rating in W 220-240V			
			Radiant Single (Left)	Radiant Double (Left)	Radiant Single (Middle)	Induction (Right)
	215	1	24	57	36	100
		2	48	114	72	200
		3	112	266	168	300
	156	4	144	342	216	500
		5	200	475	300	700
	215	6	248	589	372	900
		7	360	855	540	1100
		8	512	1216	768	1300
		9	800	1900	1200	1500
		Booster "P"				2000

Guide to the hob

MH-03IRB, MH-03IRB S, MH-03IRB LB, MH-03IRB DB, MH-03IRB BR

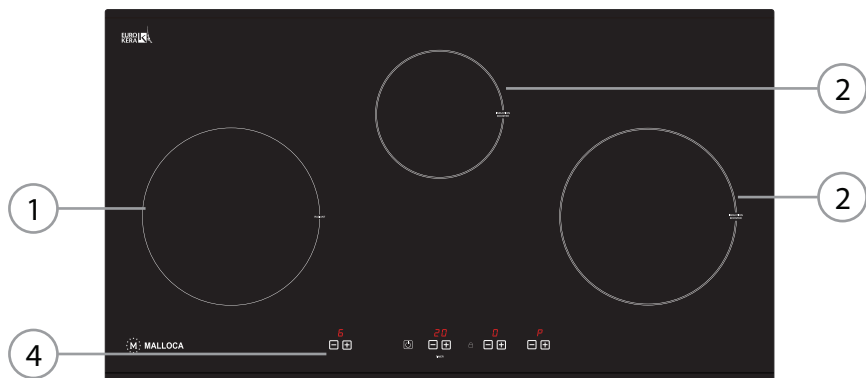
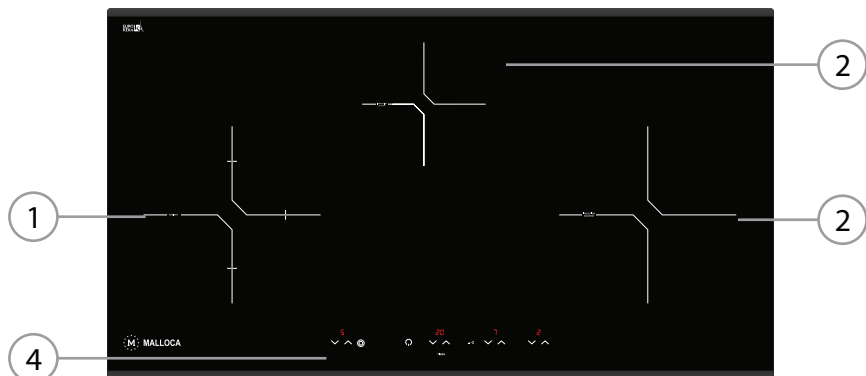
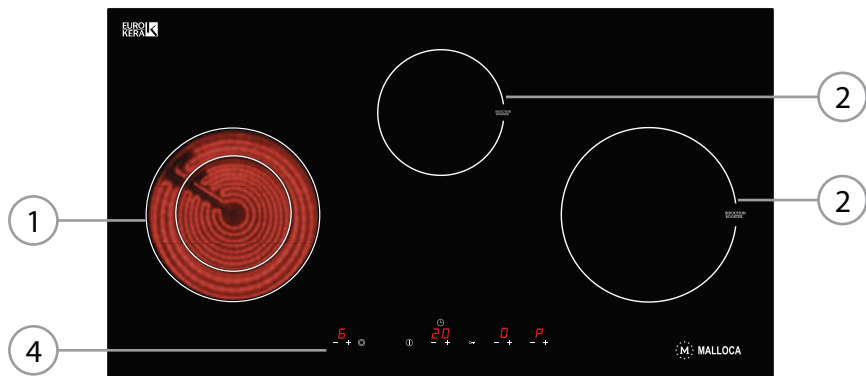

- ① Radiant heater
- ② ③ Induction heaters
- ④ Control panel

Control panel

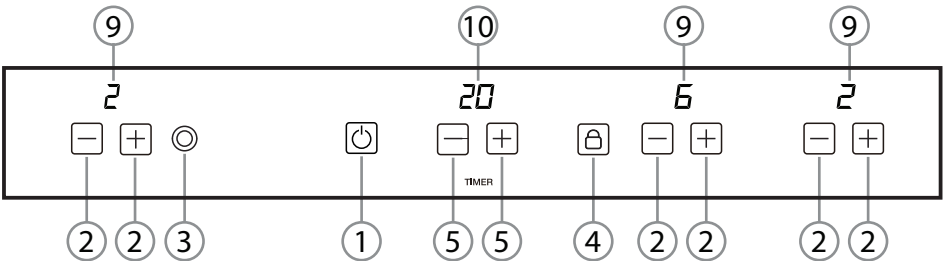
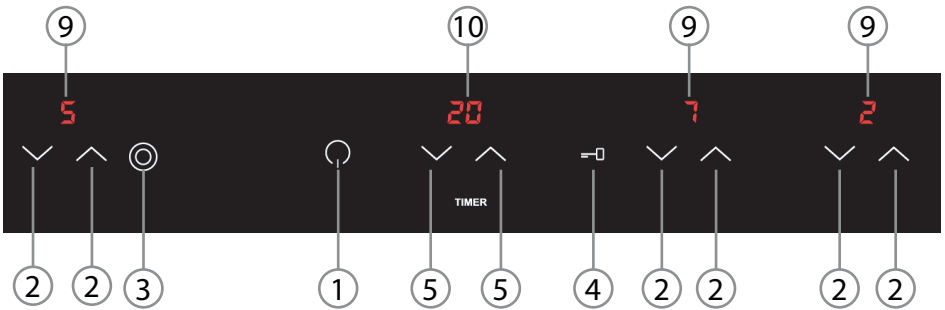
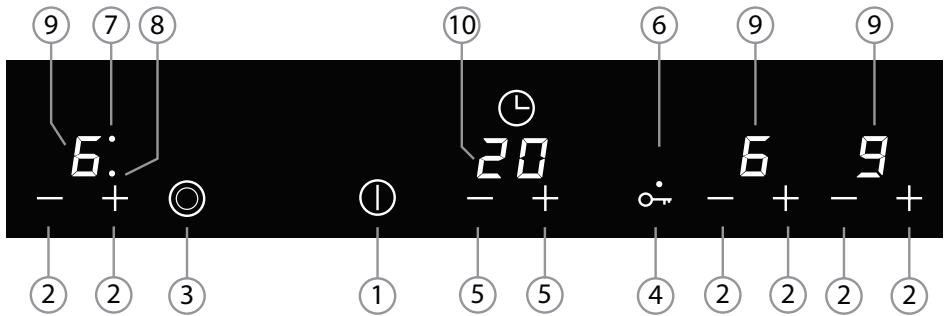

Sensors for

- ① Turning the hob on and off
- ② Setting the power level
- ③ Turning double zone on and off
- ④ Child safety lock
- ⑤ Setting the timer

Indicator lamps



- ⑥ Child safety lock
- ⑦ Timer
- ⑧ Heat-up

Display

- ⑨ Power level, residual heat display
- ⑩ Timer display

Guide to the hob

Heater data

Heater Ø in mm	Power level	Rating in W 220-240V			
		Radiant Single (Left)	Radiant Double (Left)	Induction (Middle)	Induction (Right)
 215	1	24	57	75	100
	2	48	114	150	200
 150	3	112	266	300	300
	4	144	342	400	500
 215	5	200	475	500	700
	6	248	589	600	900
	7	360	855	800	1100
	8	512	1216	1000	1300
	9	800	1900	1200	1500
	Booster "P"			1600	2000

MH-04IR & MH-04IR S

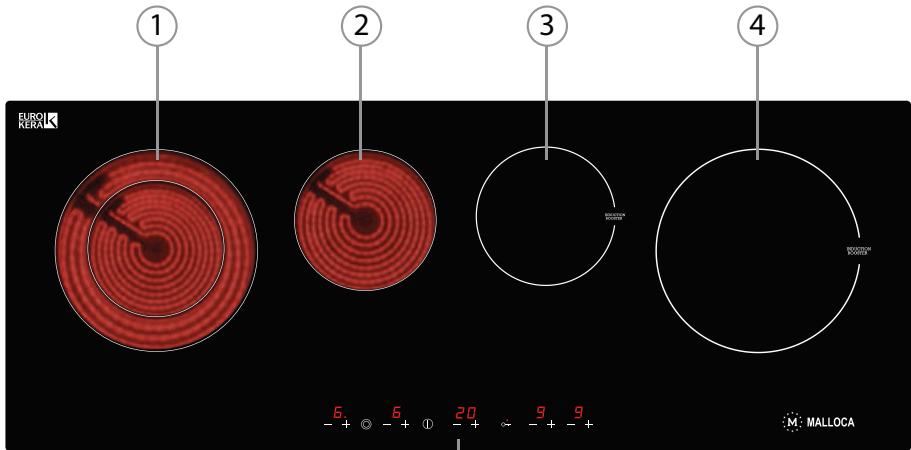

5

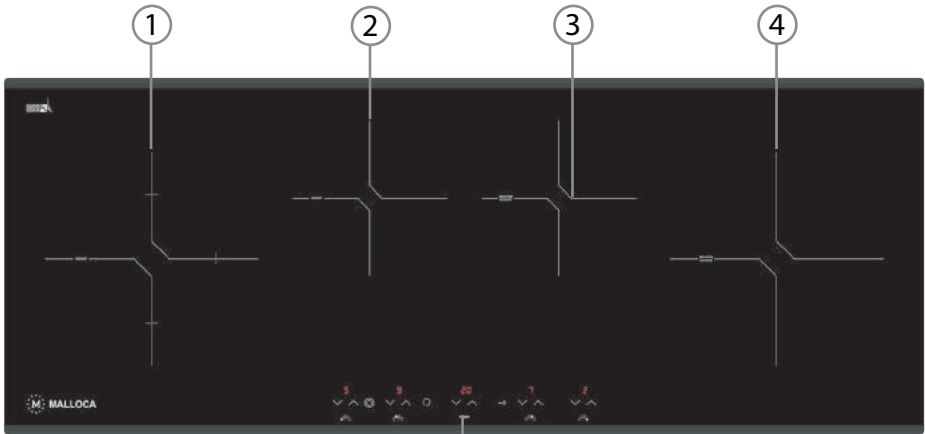

4

- ① ② Radiant heaters
- ③ ④ Induction heaters
- ⑤ Control panel for radiant heaters
- ⑥ Control panel for induction heaters

Guide to the hob

Control panel

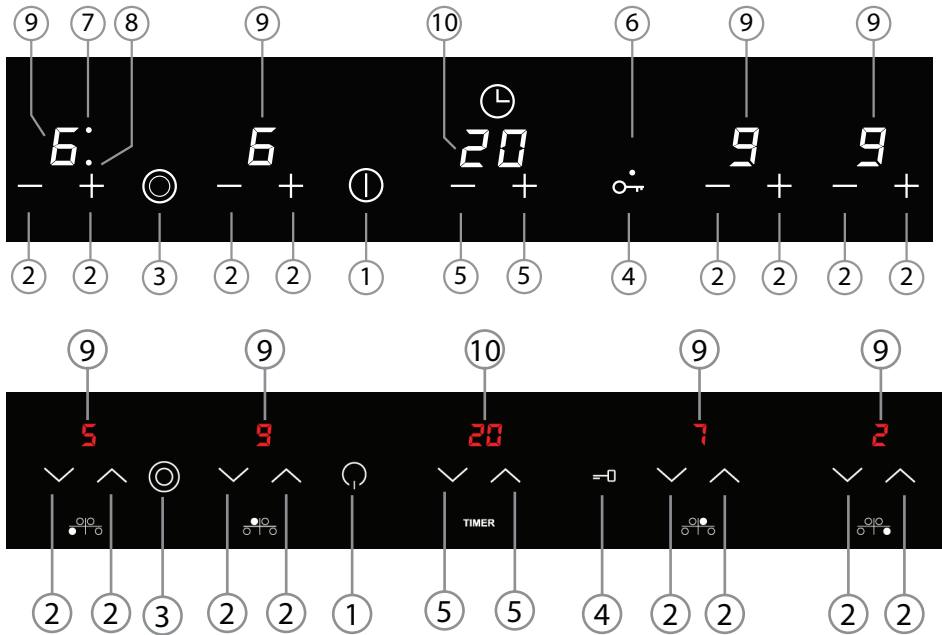

Sensors for

- ① Turning the hob on and off
- ② Setting the power level
- ③ Turning double zone on and off
- ④ Child safety lock
- ⑤ Setting the timer





Indicator lamps

- ⑥ Child safety lock
- ⑦ Timer
- ⑧ Heat-up

Display

- ⑨ Power level, residual heat display
- ⑩ Timer display

Heater data

Heater Ø in mm	Power level	Rating in W 220-240V				
		Radiant Single (Left)	Radiant Double (Left)	Radiant Single (Middle)	Induction (Middle)	Induction (Right)
 215	1	24	57	36	75	100
	2	48	114	72	150	200
	3	112	266	168	300	300
 156	4	144	342	216	400	500
	5	200	475	300	500	700
 156	6	248	589	372	600	900
	7	360	855	540	800	1100
 215	8	512	1216	768	1000	1300
	9	800	1900	1200	1200	1500
	Booster "P"				1600	2000

INDUCTION

How induction works

An induction coil is located under each heater. When a heater is switched on, this coil creates a magnetic field which impacts directly on the base of the pan and heats it up. The heater itself is heated indirectly by the heat given off by the pan.

Induction heaters only work when a magnetic based pan is placed on it (see “Cookware”).

Induction automatically recognizes the size of the pan, i.e. heat is only generated in the area covered by the base of the pan.

The heater will not work:

- ~ If it is switched on without a pan in place, or if the pan is unsuitable (non-magnetic base).
- ~ If the diameter of the pan is too small.
- ~ If the pan is taken off the heater when it is switched on.

If this happens, “u” will flash in the relevant heater display alternating with 0 or the last selected power level selected.

If a suitable pan is placed on the heater the “u” will go out and you can continue cooking as normal.

If no pan or an unsuitable pan is placed on the heater, the heater and the hob will switch off automatically after 1 minutes.

Be careful not to place cutlery or other metal objects on the hob. When the hob is switched on, or when there is residual heat present, there is the risk of metal objects heating up quickly. Beware of burns.

Depending on the material, other objects left on the hob could also melt or catch fire. Switch the heaters off after use.

Noises

When using an induction heater, the following noises can occur in the pan, depending on what it is made of and how it is constructed.

~ Higher power settings may cause a buzz. This will decrease or cease altogether when the power setting is reduced.

~ If the pan is base is made of layers of different materials (e.g. a sandwiched base), a cracking sound may be heard.

~ Whistling might occur if linked burners (see “ Booster function”) are being used on the highest setting at the same time, and the pans have bases made of layers of different materials.

~ You may hear a clicking sound from the electronic switches, especially on lower settings.

~ The hob has a cooling fan to help extend the life of the electronics. When the hob is being used at high levels for a long period of time, this will come on and you will hear a whirring sound. The fan may continue to run after the hob has been switched off.

Cookware

Suitable pans include:

- ~ Stainless steel pans with a magnetic base
- ~ Enameled steel pans
- ~ Cast iron pans
- ~ Use always flat base pans

Unsuitable pans:

- ~ Stainless steel pans without a magnetic base
- ~ Aluminum and copper pans
- ~ Glass, ceramic or earthenware pots and pans

To test whether a pot or pan is suitable for use on an induction hob, hold a magnet to the base of the pan. If the magnet sticks, the pan is suitable.

There is a different kind of pots and pans material in theory suitable for induction. There are a lot of very bad pots quality that change the induction cooking performance in general. The point is that there is not any standard to evaluate if the pot is suitable or not for induction technology.

Unless the pan manufacturer states that you can do so, do not use pans with very thin bases on this hob, and never heat up empty pans. This could damage the hob and cookware.

Pan size

To make optimum use of the heaters, choose cookware that fits between the inner and outer marking of the heater. If the base diameter of the pan is smaller than the inner marking, the induction heating will not work. The heater will behave as if it had no pan on it.

COIL	MINIMUM PAN
210 mm	180 mm
145 mm	140 mm

Use

Turning on the hob

Put a pot or pan on the desired heater.

Touch the ON/OFF touch control.

You will see 0 in each of the Heater displays. If the selection of the Heater is not done in 10 seconds the hob will be turned off automatically as a safety measure.

Turning on a Heater

When the hob is on, the power level for a heater can be selected by touching the [-] [+] / [v] [^] touch control. In each increase/ decrease a beep sounds and the corresponding display shows the new power level.

The [-] [+] / [v] [^] touch control will be locked:

- If the cooktop is off, or
- If the Child Safety Lock is activated (CHILD SAFETY LOCK LED on), or
- If there is any heater error or appliance error.

The [+] / [^] touch control raises the cooking level to 9



The [-] / [v] touch control reduces the cooking level to 0. With the Heater at power level 0, the [-] / [v] touch control raises the cooking level to 9



Booster function

Each heater is equipped with a booster function to temporarily increase the power level. When the booster function is on, the heaters increase to maximum power level for 10 minutes and its display shows "P"

With the heater at power level 9, the [+] / [^] touch control will raise the power level to P



After these ten minutes, a beep sound and the heater will return to power level 9. This booster is intended for quickly bringing large quantities of water to the boil, e.g. cooking pasta.

Taking a pan off the heater while the booster is in operation interrupts the booster function. It will resume if a pan is placed back on the heater.

The booster can be switched off by touching the [-] / [v] touch control.

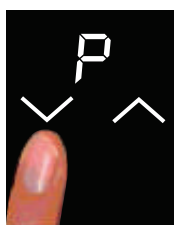

Use

Turning Off A Heater

When a heater is on, the heater can be turned off by touching the [-] / [v] and [+] / [^] touch control simultaneously. A beep sounds and its display shows "0".



Turning off the hob

Touch the On/Off touch control for the hob.

All heaters are turned off. If any heaters are still hot the residual heat indicator will show in the respective display.

The ON/OFF touch control will be locked to switch On the hob:

- If the Child Safety Lock is activated CHILD SAFETY LOCK LED on, or
- If there is any appliance error.

Residual heat indicator

While a temperature on the hob ceramic surface is above 65oC, this condition will be shown in the associated display, by means of an "H"

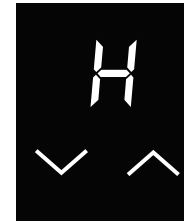
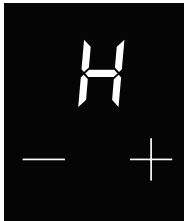

The residual heat indicator also reacts to hot dishes and plates being placed on a heater that is not switched on.

Do not touch any heater or place any heat sensitive items on a heater where the residual heat indicator is lit. Danger of burns and fire hazard.

Please note that the residual heat indicators do not light when there is a fault message, even if the heaters are hot.

Timer

The hob has a timer which can be used to automatically switch-off one (any) heater.

Quick Guide:

Turn on	Touch [-] / [V] or [+] / [^]
Set	With [-] / [V] set from 99 to 00 minute With [+] / [^] set from 00 to 99 minutes
Reset back to 00	Touch [-] / [V] and [+] / [^] simultaneously

Setting the timer

The timer can be set with the hob turned on. It can be set from 1 to 99 minutes.

Touch [-] / [V] or [+] / [^] touch control to turn the timer on.

The display shows 00.

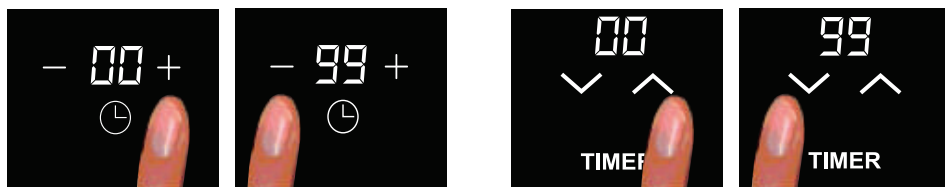

Touch the [-] / [V] or [+] / [^] to select the heater on which the timer function is to operate. The selection of a heater of a new heater disables the previous selection in such a way that the timer only operates on one heater each time.

The heater must always be selected before the time is set; otherwise, the timer will switch off.

If, after selecting the heater, the time is not defined (T=00) in 10 sec., the timer switches off.

The set time counts down in minutes in the timer display. The remaining time is displayed and can be changed at any time by pressing [-] / [V] or [+] / [^].

After the set time has elapsed the display shows 00 and an audible signal is heard. After a few seconds the tone will stop and the 00 will go out.

To end the signal select the [-] / [V] or [+] / [^] touch control.

Safety Features

Child Safety Lock

Keep children away from the hob for their own safety.

The hob has a Child Safety Lock to prevent children from turning on the heaters or changing the settings.

The Child Safety Lock can be activated while the hob is on or off.

Activating the Child Safety Lock during hob use

The settings for the heater and timer cannot be altered.

The heaters and hob can still be turned off but once turned off cannot be turned on again.

Activating the Child Safety Lock when the hob is turned off

The hob cannot be turned on.

To activate the Child Safety Lock

Press and hold the Child Safety Lock control until the respective indicator lights.

If you touch the Child Safety Lock control or setting, the indicator will come on to show that the Child Safety Lock is activated.

To deactivate the Child Safety Lock

Press and hold the Child Safety Lock control until the indicator goes out. In the case of a power failure the Child Safety Lock will be deactivated.

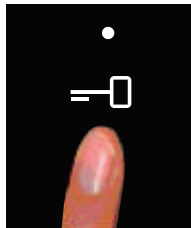
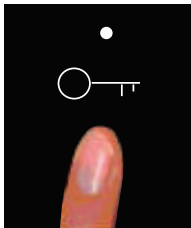

Automatic Safety Off

The hob has an automatic safety off in case it is not turned off after use.

If one of the heater is heated for an unusually long period of time (see table), and the power level settings are not adjusted, the hob will turn itself off automatically and the residual heat indicator will light.

To use the heaters again, switch the hob back on in the usual way.

Power level	Max Operating hr.
1	10
2	10
3	10
4	10
5	10
6	10
7	10
8	10
9	3

Covered touch controls

The hob will turn off automatically if any of the touch controls are covered for more than 10 seconds, e.g. by finger contact, food boiling over or by an object such as an oven mitt or towel.

Clean the touch controls or remove the object covering it.

Turn the hob on again with the ON/OFF touch control. The heater can now be used.

Safety features

Overheating protection

The induction coils and the cooling element of the electronic are fitted with an overheating protection feature. This prevents the induction coils and cooling element from overheating.

This mechanism works on the affected heater or on the entire hob in the following ways:

- If the booster function is being used, it will be switched off.
- If an induction coil is affected, the heater will automatically turn off. 0 and the residual heat indicator will show in the display.

The heater can be used again as soon as it has cooled to a safe temperature.

- If the cooling system is affected, all heaters will automatically turn off, and the display will show 0 alternating the set power level.

Once the system has sufficiently cooled, the heaters will automatically operate at the originally set power level.

Overheating can be caused by:

- heating an empty pan.
- fats or oils being heated on the highest power setting.
- there being insufficient ventilation to the under side of the hob

If the overheating protection mechanism triggers again, contact Malloca Technical Service.



RADIANT

How the cooking zone work

Single circle cooking zones have one heating element, whilst double circle (vario) cooking zones have two.

Each cooking zone has overheating protection (a temperature limiter), which stops the ceramic surface from becoming too hot (see "Overheating protection").

When a power level is selected, the heat switches on and the element can be seen through the ceramic surface.

The temperature of the cooking zone depends on the power level selected, and is electronically regulated. This controls the "timing" of a cooking zone, switching the element on and off.

Double circle zone

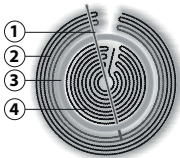

- ① Overheating protection
- ② Outer heating element
- ③ Isolating ring
- ④ Inner heating element

Single circle zone

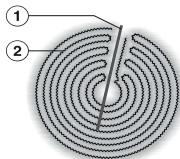

- ① Overheating protection
- ② Heating element

Suitable pans

Most suitable

The best pans for use on a ceramic hob are those with a thick base which is very slightly concave when cold. When heated, the base flattens to rest evenly on the hob, optimising the conduction of the heat.

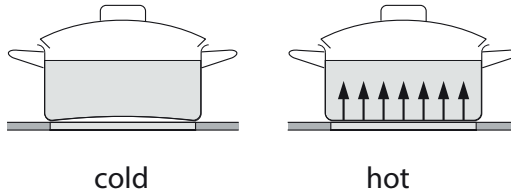

Less suitable

Pans made of glass, ceramic or stoneware are less suitable, as they do not conduct the heat so well.

Not suitable

Dishes or containers made from plastic or aluminium foil must not be used as these melt at high temperatures.

- Aluminium pans or pans with an aluminium base can cause metallic, shiny marks to appear on the ceramic surface. These marks can be removed using a ceramic and stainless steel hob cleaner (see “Cleaning and care”).
- Do not use pots and pans on the hob with bases with pronounced edges or ridges.

These could scratch or scour the hob surface permanently.

- Lift pans into position on the hob. Sliding them into place can cause scuffs and scratches.
- Often the maximum diameter quoted by manufacturer refers to the diameter of the top rim of the pot or pan. The diameter of the base (generally smaller) is more important.

Tips on saving energy

- Check that the diameter of the pan base is wide enough for the cooking zone so that heat is not lost unnecessarily.

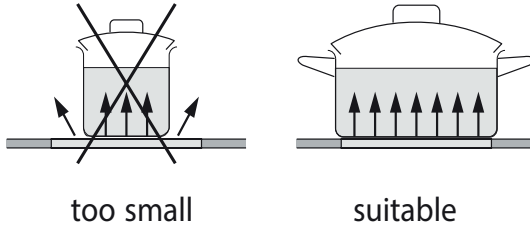

- Use a pan lid whenever possible to minimise heat loss.

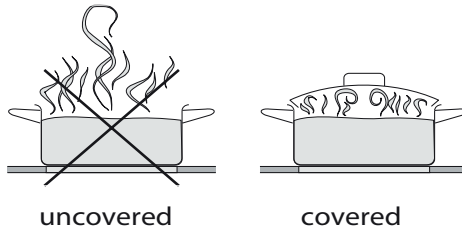

- Select a smaller pan when cooking small quantities. A small pan on a small cooking zone uses less energy than a large, partially filled pan on a large cooking zone.
- Cook with as little water as possible.
- Once food has come to the boil or the oil in the pan is hot enough for frying, reduce the heat to a lower setting.
- When cooking for a long time, switch the cooking zone off about 5 to 10 minutes before the end of the cooking time. In this way, use is made of the residual heat.
- Cooking times are greatly reduced when using a pressure cooker.

Use

Turning on the hob

Put a pot or pan on the desired heater.

Touch the ON/OFF touch control.

You will see 0 in each of the heater displays. If the selection of the heater is not done in 10 seconds the hob will be turned off automatically as a safety measure.

Turning on a heater

When the hob is on, the power level for a heater can be selected by touching the [-] [+] / [v] [^] touch control. In each increase/ decrease a beep sounds and the corresponding display shows the new power level.

The [-] [+] / [v] [^] touch control will be locked:

- If the cooktop is off, or
- If the Child Safety Lock is activated (CHILD SAFETY LOCK LED on), or
- If there is any heater error or appliance error.

The [+] / [^] touch control raises the cooking level to 9

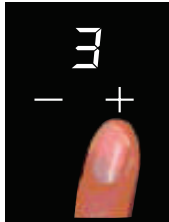

The [-] / [v] touch control reduces the cooking level to 0. With the Heater at power level 0, the [-] / [v] touch control raises the cooking level to 9



Heat-up function

Activating the heat-up function

This function takes the cooking level to maximum power for a defined time.

The heat-up function is activated by selecting the power level 9 and touching the [+] / [^] key.

The decimal point of the display blinks for 10 seconds.

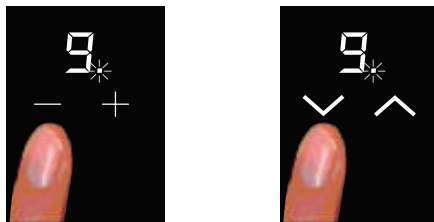

During these 10 seconds the desired power level must be selected (between 1 and 8). After this time a beep sound and the decimal point remains fixed, indicating the heat-up function is on. If the power level is 0 or 9, the heat-up function is cancelled.

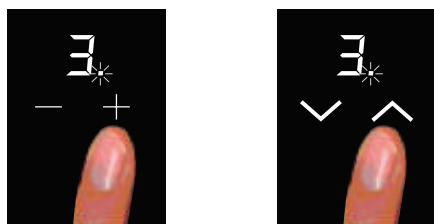

If the heat-up function is activated, pressing the heater [+] / [^] key, the duration of the heat-up function will be the duration for the new power level, if the new level is 9, the heat-up function is cancelled.

Power level	1	2	3	4	5	6	7	8
Time (sec.)	1'12"	2'44"	4'48"	5'28"	6'30"	1'12"	2'44"	2'44"

Cancelling the heat-up function

The heat-up function can be cancelled either automatically, when the time expires or when the user wishes.

When the heat-up function is cancelled automatically, a beep sounds, the decimal point of the display turns out and the power level of the heater remains the selected power level.

If you press the [-] / [v] key when the heat-up function is activated, this function is cancelled.

Use

Turning Off A Heater

When a heater is on, the heater can be turned off by touching the [-] / [v] and [+] / [^] touch control simultaneously. A beep sounds and its display shows "0".

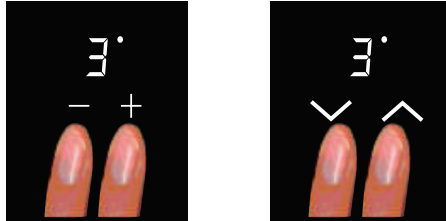

Turning off the hob

Touch the On/Off touch control for the hob.

All heaters are turned off. If any heaters are still hot the residual heat indicator will show in the respective display.

The ON/OFF touch control will be locked to switch On the hob:

- If the Child Safety Lock is activated CHILD SAFETY LOCK LED on, or
- If there is any appliance error.

Residual heat indicator

While a temperature on the hob ceramic surface is above 65oC, this condition will be shown in the associated display, by means of an "H"

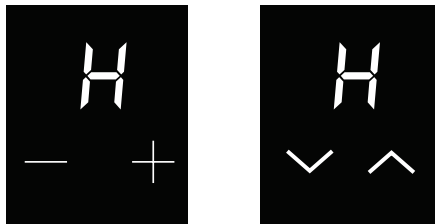

The residual heat indicator also reacts to hot dishes and plates being placed on a heater that is not switched on.

Do not touch any heater or place any heat sensitive items on a heater where the residual heat indicator is lit. Danger of burns and fire hazard.

Please note that the residual heat indicators do not light when there is a fault message, even if the heaters are hot.

The hob has a timer which can be used to automatically switch-off one (any) heater.

Quick Guide:

Turn on	Touch [-] / [V] or [+] / [^]
Set	With [-] / [V] set from 99 to 00 minute With [+] / [^] set from 00 to 99 minutes
Reset back to 00	Touch [-] / [V] and [+] / [^] simultaneously

Setting the timer

The timer can be set with the hob turned on. It can be set from 1 to 99 minutes.

Touch [-] / [V] or [+] / [^] touch control to turn the timer on.

The display shows 00.



Touch the [-] / [V] or [+] / [^] to select the heater on which the timer function is to operate. The selection of a heater of a new heater disables the previous selection in such a way that the timer only operates on one heater each time.

The heater must always be selected before the time is set; otherwise, the timer will switch off.

If, after selecting the heater, the time is not defined (T=00) in 10 sec., the timer switches off.

The set time counts down in minutes in the timer display. The remaining time is displayed and can be changed at any time by pressing [-] / [V] or [+] / [^].

After the set time has elapsed the display shows 00 and an audible signal is heard. After a few seconds the tone will stop and the 00 will go out.

To end the signal select the [-] / [V] or [+] / [^] touch control.

Safety features

Child Safety Lock

Keep children away from the hob for their own safety.

The hob has a Child Safety Lock to prevent children from turning on the Heaters or changing the settings.

The Child Safety Lock can be activated while the hob is on or off.

Activating the Child Safety Lock during hob use

The settings for the heater and timer cannot be altered.

The heaters and hob can still be turned off but once turned off cannot be turned on again.

Activating the Child Safety Lock when the hob is turned off

The hob cannot be turned on.

To activate the Child Safety Lock

Press and hold the Child Safety Lock control until the respective indicator lights.

If you touch the Child Safety Lock control or setting, the indicator will come on to show that the Child Safety Lock is activated.

To deactivate the Child Safety Lock

Press and hold the Child Safety Lock control until the indicator goes out. In the case of a power failure the Child Safety Lock will be deactivated.

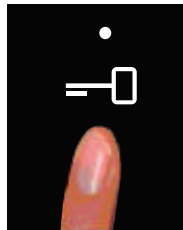
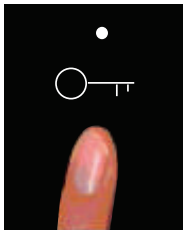

Automatic Safety Off

The hob has an automatic safety off in case it is not turned off after use.

If one of the heater is heated for an unusually long period of time (see table), and the power level settings are not adjusted, the hob will turn itself off automatically and the residual heat indicator will light.

To use the heaters again, switch the hob back on in the usual way.

Power level	Max Operating hr.
1	10
2	5
3	5
4	4
5	3
6	2
7	2
8	2
9	1

Covered touch controls

The hob will turn off automatically if any of the touch controls are covered for more than 10 seconds, e.g. by finger contact, food boiling over or by an object such as an oven mitt or towel.

Clean the touch controls or remove the object covering it.

Turn the hob on again with the ON/OFF touch control. The heater can now be used.

Safety features

Overheating protection

Each zone is equipped with overheating protection (internal temperature limiter). This switches off the heating elements in the cooking zone before the ceramic surface overheats.

If the heating element switches on and off even when the highest power level is selected, this indicates that the overheating protection mechanism has triggered.

Once the ceramic surface has cooled down to a safe level, the heating element will automatically switch back on again.

Overheating can be caused by:

- a cooking zone being switched on without a pan on it.
- heating up an empty pan.
- the base of a pan not sitting evenly on the cooking zone.
- the pan not conducting heat properly.

Cut out

Make the countertop cut-out following the dimensions given in the illustration.

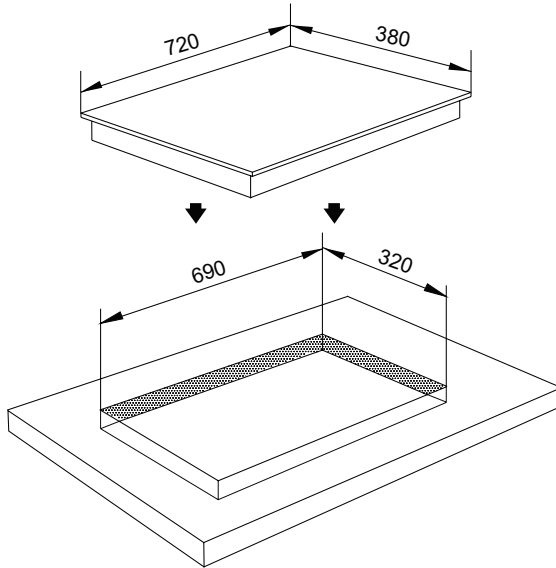

Code	Cut out dimension
MDH-02I	250 x 475 mm
MH-02I, MH-02I D, MH-02I PG/SB/TB	660 x 325 mm
MH-03I	530 x 475 mm
MH-04I	530 x 475 mm
MH-02IR, MH-02IR D, MH-02IR PG/SB/TB	690 x 320 mm
MH-03IRA	770 x 400 mm
MH-03IRB, MH-03IRB S, MH-03IRB LB/DB/BR	770 x 400 mm
MH-04IR, MH-04IR S	895 x 325 mm

Remember to maintain a minimum distance of 50 mm between the rear wall and the right or left side. See also the “IMPORTANT SAFETY INSTRUCTIONS”.

This hob has a seal underneath to keep it securely in position. Spring clips are not

required. Any gap between the frame and the countertop will reduce as the hob is used.

Electrical Connection

CAUTION:

Before installation or servicing, disconnect the power supply by either removing the fuse, shutting off the main power supply or manually “tripping” the circuit breaker.

Installation work and repairs should only be performed by a qualified technician in accordance with all applicable codes and standards. Repairs and service by unqualified persons could be dangerous and the manufacturer will not be held responsible.

Before connecting the appliance to the power supply, make sure that the voltage and frequency listed on the data plate correspond with the household electrical supply. This data must correspond to prevent appliance damage. Consult an electrician if in doubt.

Only operate the cooktop must not be permanently sealed into the countertop when installed. The sealing strip under the edge of the hob provides a sufficient seal for the countertop after it has been installed into the countertop.

Power supply

Be sure your electrical supply matches the data plate.

Connection

The cooktop is equipped with a power cord 3 wires ready for connection to a grounded power supply.

A dedicated line and junction box should be used to connect the hob to a circuit.

MDH-02I	: 20A
MH-02I, MH-02I D, MH-02I PG/SB/TB	: 20A
MH-03I	: 30A
MH-04I	: 40A
MH-02IR, MH-02IR D	: 20A
MH-03IRA	: 25A
MH-03IRB, MH-03IRB S, MH-03IRB LB/DB/BR:	30A
MH-04IR, MH-04IR S	: 32A

For further information, see the wiring diagram provided with the appliance.

WARNING: THIS APPLIANCE MUST BE GROUNDED!

MDH 02I - MH 02I - MH 02I D - MH 02I PG/SB/TB

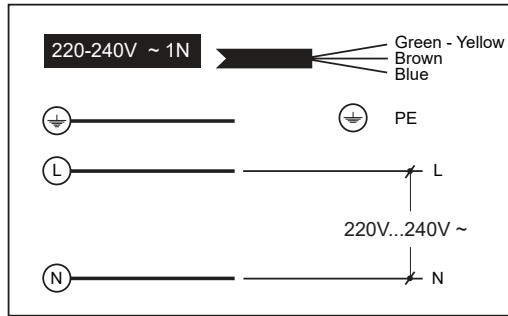

MH 03I - MH 04I

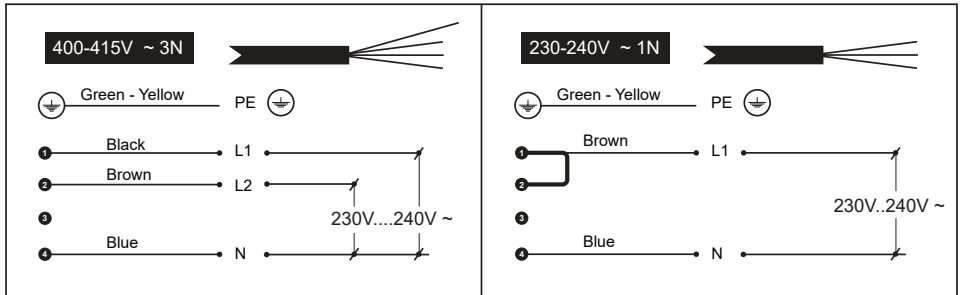

Electrical Connection

MH 02IR - MH 02IR D - MH 02IR PG/SB/TB

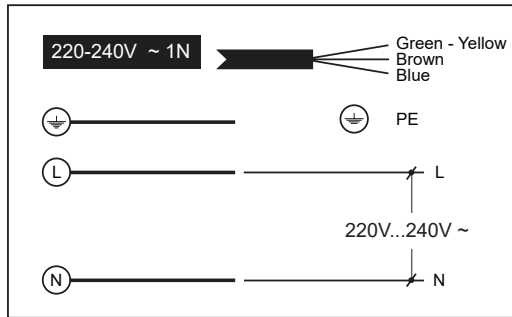

MH 03IRA - MH 03IRB - MH 03IRB S - MH 03IRB LB/DB/BR MH 04IR - MH04IR S

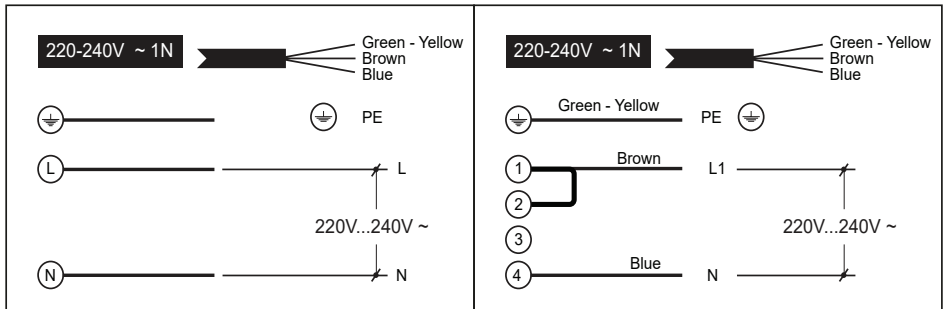

**EXCLUSIVE DISTRIBUTOR IN VIETNAM
MALLOCA VIETNAM CO., LTD**

Office and Showroom:

279 Nguyen Van Troi St., Ward 10, Phu Nhuan Dist., HCM City

Tel: (84) 28 39975 893 / 94

Hotline: 1800 12 12

Fax: (84) 28 39970 135

Email: info@malloca.com