

For original parts & reliable service :

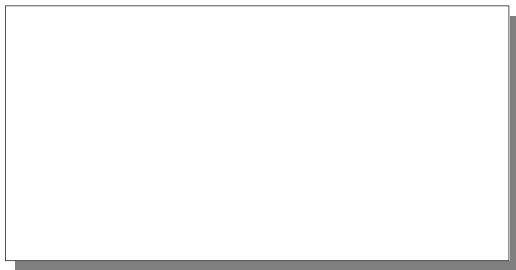

---

*DESIGNER SLIM HOOD*

**USER MANUAL**

**INSTALLATION INSTRUCTIONS**



## Table of Contents

- From the Manufacturer 3
- Specifications 3
- SAFETY : Read this first ! 4
- Vent System Requirement 5
- Description of Parts 6
- Ducted vs. Re-circulating modes 7
- Setting 8
- Installation 9, 10
- Electrical Connection 11
- Operation 12
- Cleaning & Maintenance 13
- Troubleshooting 14
- Schematic Diagram 15

## Schematic Diagram

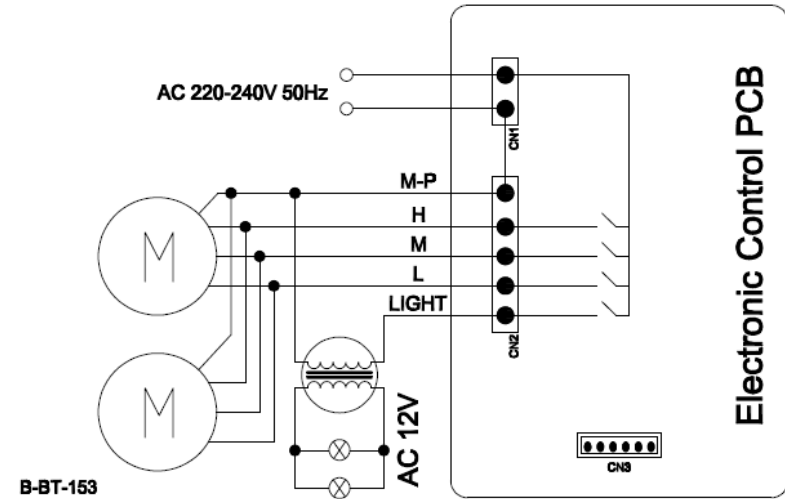

## Troubleshooting

Symptoms	Possible Cause	Action
Does not function	No electrical supply	Check that the plug is connected.
		Check that the main switch is turned on.
Poor airflow	Aluminium grease filters clogged	Clean the filters and replace when dry
	Charcoal grease filters clogged	Replace charcoal filters with new sets
Motor running but no airflow	Butterfly valve jammed	Contact technician
Motor cuts after a few minutes	High temperature safety device activated	The kitchen is not sufficiently ventilated
	The hood is installed too near the cooking stove	The hood must be least 65cm from stove
Strong cooking smell	Charcoal filters not installed	In re-circulating mode, charcoal filters must be installed
Oil dripping onto stove	Alluminium grease filter saturated	Wash the aluminium grease filters
	Aluminium grease filter saturated	Wash the aluminium grease filters
Whirring sound	Foreign object in contact with fan blade	Contact technician

## • From the Manufacturer

- This appliance and it's packaging are produced by processes that minimize waste and respect the environment.
- Please help us to continue the protection of the environment by disposing of the packaging in a correct manner.
- **Safety !**
- Please do not allow young children to play with the plastic bag packaging.
- Before disposing of any old appliances, be sure to cut off the power chord so that others will not be endangered by a defective electric appliance

## Specifications

Input : 220-240V 50Hz

Absorbtion

• 2 motor version : 170W

• 1 motor version : 105W

Lamps : 2 X 20W

Total Power

• 2 motor version : 210W

• 1 motor version : 145W

External Dimensions

## **SAFETY : Read this First !**

- Do not connect the appliance if there are obvious signs of transportation damage.
- Read this user manual thoroughly before attempting to use this appliance.
- Installation and repair should be attempted only by qualified technical personnel.
- It is dangerous to modify any part of this appliance.
- The manufacturer declines all responsibility in case of failure to adopt proper safety measures.
- Ensure the location in which this appliance is installed has good, permanent ventilation.
- The distance between the bench top to the lower part of the hood must not be at less than 65 cm or higher than 75 cm.
- Use an electrical connector with earth that is correct for your location.
- Check that the voltage in your area is correct before plugging in.
- The electrical connection of this appliance must be connected to earth.

<b>Green &amp; yellow</b>	<b>=</b>	<b>EARTH</b>
<b>Blue</b>	<b>=</b>	<b>NEUTRAL</b>
<b>Brown</b>	<b>=</b>	<b>LIVE</b>
- Multiple plugs and extension cables must not be used. Overload is dangerous and may cause a fire.
- Ensure that the power supply chord is free from any heat source or sharp objects.
- The appliance should be switched off and the electrical supply disconnected before any cleaning or maintenance work can be carried out.

## **Cleaning & Maintenance**

**SURFACES** : Wash with warm soapy water and a soft sponge. Never use abrasive detergent, scouring pads, steel wool or solvents on any part of this appliance as this will cause irreparable damage.

### **GREASE FILTERS - Maybe one of the following:**

**Aluminium Grease Filters** : Wash in the dishwashers or soak the panels in a degreasing agent for an hour, then rinse off.

**Baffle Filters** : The baffle grease filters should be cleaned frequently in hot detergent solution or washed in the dishwasher. Clean exterior surfaces with a commercially available stainless steel cleaner. Abrasives and scouring agents can scratch stainless steel finishes and should not be used to clean finished surfaces.

**CHARCOAL FILTERS** (only in re-circulating model) : Charcoal cannot be reused. They must be replaced with the appropriate types once a year or depending on the frequency of appliance usage.

For this appliance to function effectively, regular maintenance is a must. Clogged filters restrict airflow and may cause the motor to overheat.

**LIGHT BULB REPLACEMENT** : Before attempting to replace the light bulb, make sure that the light switch is turned off. Remove the grease filter to access the lamp area. Remove the damaged light bulb and replace with an incandescent oval bulb maximum 40W.

## Operation

The hood is equipped with 3 speed control. Electronic control buttons are located on the front edge of the range hood canopy or enrichment panel.

Use the low speed for simmering, medium speed for light cooking.

Use the high speed for frying or heavy cooking.

It is also equipped with a light bulb to illuminate your cooking area when needed.

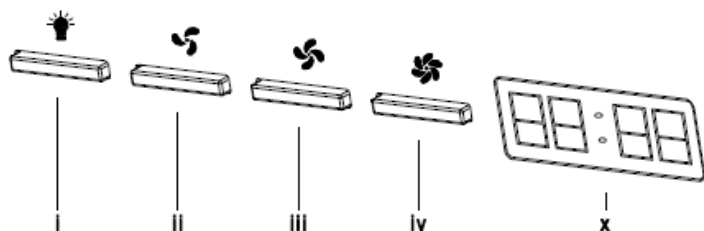

### Light On/Off Button (i)

Switch the lighting system on and off.

### Blower On and Speed Buttons ( ii, iii & iv)

Button (ii) operates the blower on LOW speed and off.

Button (iii) operates the blower for MEDIUM speed and off.

Button (iv) operates the blower for HIGH speed and off.

### Clock and delay timer displayer (x)

1. Push light button for a few second to set delay timer with 3-15 minutes (3 minutes increment) when hood was on.
2. Push button (ii) for a few second to set the clock for hour display when selected LOW speed.
3. Push button (iii) for a few second to set the clock for minute display when selected MEDIUM speed.

## Vent System Requirements

Determine which venting method is best for your application. Vented (non-recirculating) system must be terminate to the outside. Ductwork can extend either through the wall or the roof. Do not terminate the vent system in an attic or other enclosed area.

The length of the ductwork and the number of elbows should be kept to a minimum to provide efficient performance. The size of the ductwork should be uniform. Do not install two elbows together. Use duct tape to seal all joints in the ductwork system. Use caulking to seal exterior wall or floor opening around the cap.

**Flexible ductwork is not recommended. Flexible ductwork creates back pressure and air turbulence that greatly reduces performance.**

Make sure there is proper clearance within the wall or floor for exhaust duct before making cutouts. Do not cut a joist or stud unless absolutely necessary. If a joist or stud must be cut, then a supporting frame must be constructed.

## Description of Parts

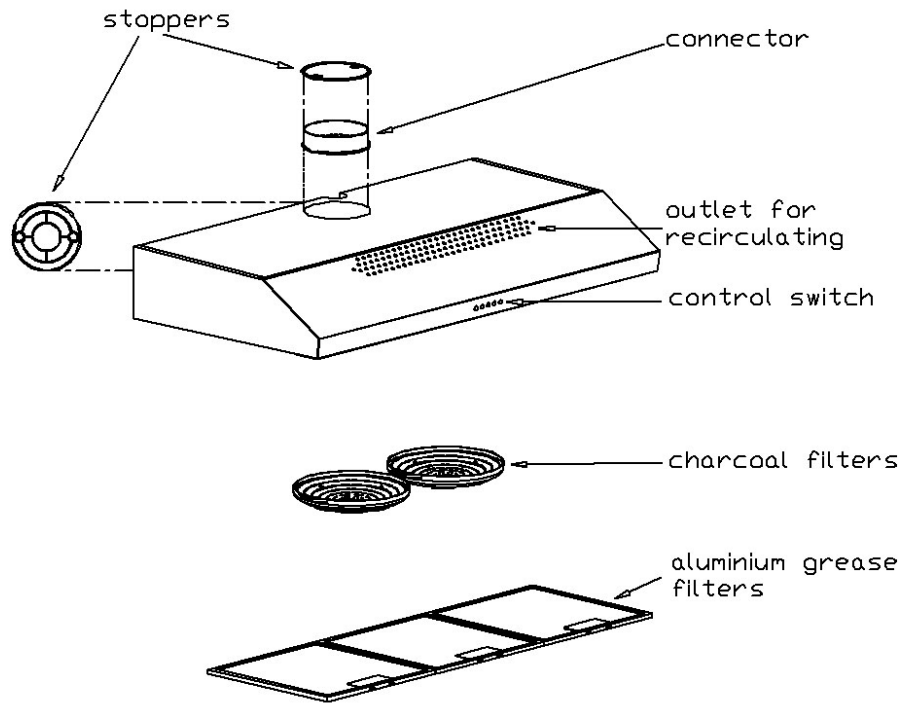

## Electrical Connection

Before completing any connection, make sure the house voltage corresponds with the voltage indicated on the label affixed inside the hood.

It is advisable to call a qualified technician to make the electrical connection.

### ***Appliance fitted with plug***

Connect it to a socket which conforms with current regulations.

If you intend to connect it directly to the electric mains, remove the plug and fit an approved bipolar switch with a minimum contact opening of not less than 3mm.

If the plug is not accessible once it has been inserted in the socket, it will however be necessary to fit an approved bipolar switch with a minimum contact opening of no less than 3mm.

### ***Appliance without plug***

Fit an approved plug or an bi-polar switch with a minimum contact opening of no less than 3mm.

The manufacturer are not liable for any problems caused by the user's failure to observe the above instructions

## Installation (2)

STEP 3 : Hang the hood on the 2 screws.

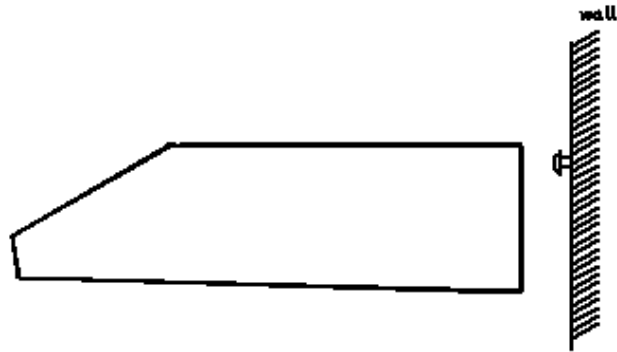

STEP 4 : Tighten the 2 screws completely.



## Ducted vs. Re-circulating

Your cooker hood can be configured to operate in the ducted or re-circulating mode :-

### A. DUCTED MODE (VENTED MODE)

- In the ducted mode, cooking fumes are vented outdoors through suitable connection of 125mm diameter. In this mode, only the aluminium filters are installed.

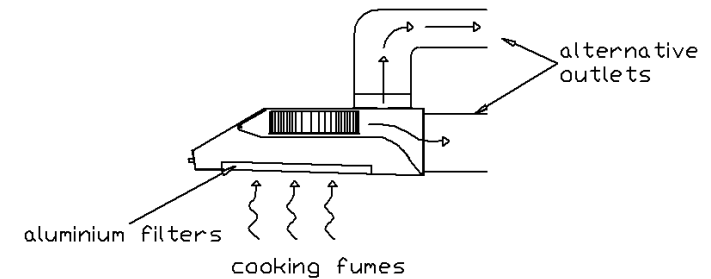

### B. RE-CIRCULATING MODE

- Fumes are filtered for grease and odour through the aluminium grease filters and the charcoal filters respectively and re-introduced into the kitchen environment. In re-circulating mode, both the aluminium grease filters and the charcoal filters must be installed.

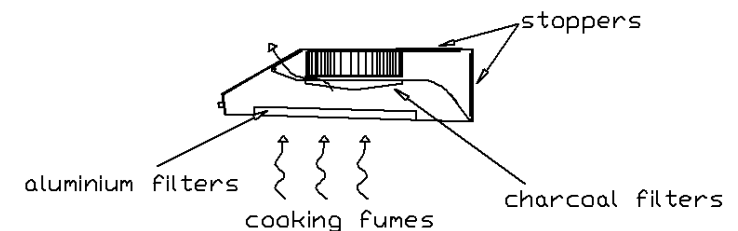

## Setting

The operating mode of your cooker hood must be set before installation

### A. To set your hood to operate in the ducted mode

- remove the aluminium grease filters and locate the 2 setting screws
- Turn the screws clockwise until locked.
- Install the outlet connector the back or top outlet and the stopper in the other.
- Remove the charcoal filters if installed.

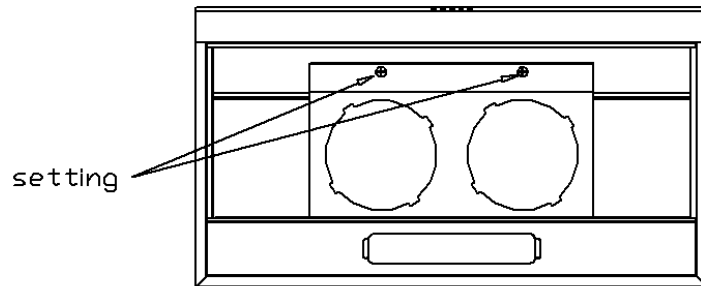

### B. To set your hood to operate in the re-circulation mode

- remove the aluminium grease filters and locate the 2 setting screws
- Turn the screws anti-clockwise until released.
- Install the stoppers in the top and back outlets.
- Install the charcoal filters if not already done so.

## Installation (1)

STEP 1 : Remove the aluminum filters and place them in a safe location to avoid damage.

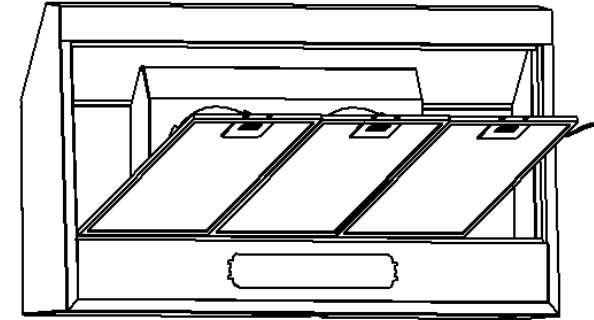

STEP 2 :  
screws on the

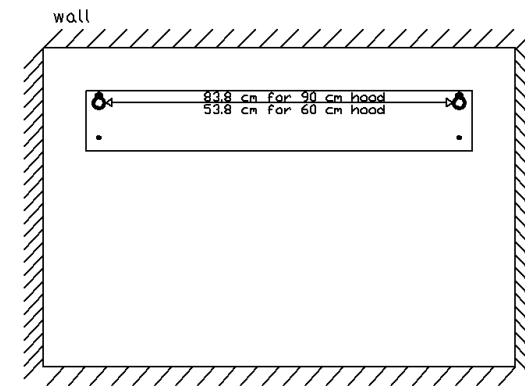

Install the 2  
wall.