

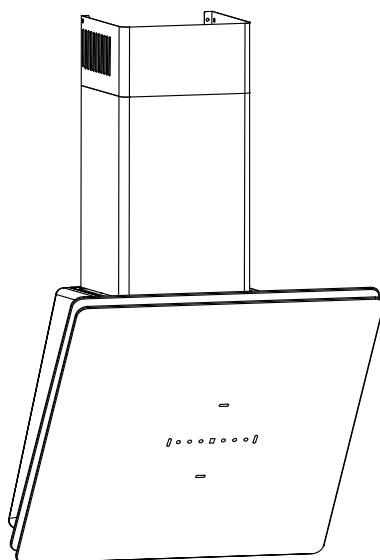

RANGE HOOD INSTRUCTION MANUAL

MC 60GT-B/MC 60GT-G



Dear Customer,

If you follow the recommendations contained in this Instruction Manual, our appliance will give you constant high performance and will remain efficient for many years to come.

Product Specification & Technical Parameters

Model	MC 60GT-B /MC 60GT-G
Rated Voltage	220V
Rated Power Frequency	50Hz
Light Power	LED 2WX2+4WX1
Motor Power	230W
Total Power	238W
Motor	1
Diameter of Outlet Adapter	150mm
Dimension (mm)	L600 X D475 X H1003~1383

RECOMMENDATIONS AND SUGGESTIONS

INSTALLATION

- * The manufacturer will not be held liable for any damages resulting from incorrect or improper installation.
- * Please read this instruction manual before installing and using this range hood. Please keep this instruction manual in a safe place for future reference.
- * Only a qualified and trained service technician can undertake the work of installation and servicing.
- * Check that the main voltage corresponds to the one indicated on the rating plate fixed inside the hood.
- * If the hood is used in conjunction with non-electrical appliances (e. g. gas burning appliances), a sufficient degree of ventilation must be guaranteed in the room in order to prevent the backflow of exhaust gas. The kitchen must have an opening directly with the open air in order to guarantee the entry of clean air.

* The minimum distance is 750mm from the range hood to a gas hob, and is 650mm to an electric hob. If the installation instructions for gas hobs specify a greater distance, this must be taken into account.

NOTICE: Two or more people are required to install or move this appliance. Failure to do so can cause physical injuries.

USE

* The range hood has been designed only for domestic use to eliminate kitchen fumes.

* Never use the hood for purposes other than what it has been designed for.

* Never leave high naked flames under the hood when it is in operation.

* Adjust the flame intensity to direct it onto the bottom of the pan only; making sure that it does not engulf the pan sides.

* Deep fat fryer must be continuously monitored during use: overheated oil can burst into flame.

* The hood should not be used by children or persons not instructed in its correct use.

MAINTENANCE

* Proper maintenance of the range hood will assure proper performance of the unit.

* Disconnect the hood from the main supply before carrying out any maintenance work.

* Clean and/or replace aluminum grease filters and activated charcoal filters after specified period of time.

* Clean the hood using a damp cloth and a neutral liquid detergent.

* **DISPOSAL:** Do not dispose this product as unsorted municipal waste. Collection of such waste separately for special treatment is necessary.

WARNING!!

In certain circumstances electrical appliances may be a danger hazard.

- * Do not check the status of the filters while the cooker hood is operating
- * Do not touch the light bulbs after appliance use
- * Do not disconnect the appliance with wet hands.
- * To reduce the risk of fire or electric shock, do not use this fan with any solid-state.
- * Avoid free flame, as it would do damage to the filters from a fire hazard
- * Constantly check food frying to avoid that the overheated oil may become a fire hazard
- * Disconnect the electrical plug prior to any maintenance or servicing.
- * Children don't recognize the risks of electrical appliances. Therefore use or keep the appliance only under supervision of adults and out of the reach from children.

* TO REDUCE THE RISK OF FIRE, ELECTRIC SHOCK, OR INJURY TO PERSONS, OBSERVE THE FOLLOWING:

- a) Installation work and electrical wiring must be done by qualified person(s) in accordance with all applicable codes and standards, including fire-rated construction.
- b) Sufficient air is needed for proper combustion and exhausting of gases through the flue (chimney) of fuel burning equipment to prevent back drafting.
- c) When cutting or drilling into wall or ceiling, do not damage electrical wiring and other hidden utilities.
- d) Ducted fans must always be vented to the outdoors.

- * Don't use this product outdoors.
- * This appliance is not intended for use by persons (including children) with reduced physical, sensory or mental capabilities, or lack of experience and knowledge, unless they have been given supervision or instruction, concerning use of the appliance by a person responsible for their safety. Children should be supervised to ensure that they do not play with the appliance.
- * There shall be adequate ventilation of the room when the range hood is used at the same time as appliances burning gas or other fuels.

- * There is a fire risk if cleaning is not carried out in accordance with instructions.
- * The exhaust air must not be discharged into a flue which is used for exhausting fumes from appliances burning gas or other fuels.

CHARACTERISTICS

DIMENSIONS

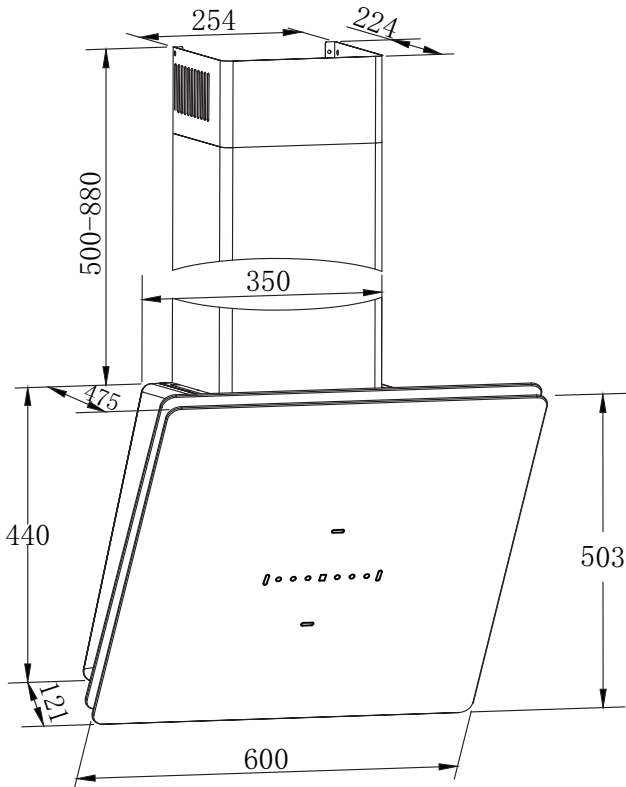

INSTALLATION & USE

OPERATION OF CONTROLS

Control panel is shown in **Figure 1**, for reference it is also shown below:

This appliance features gesture control:

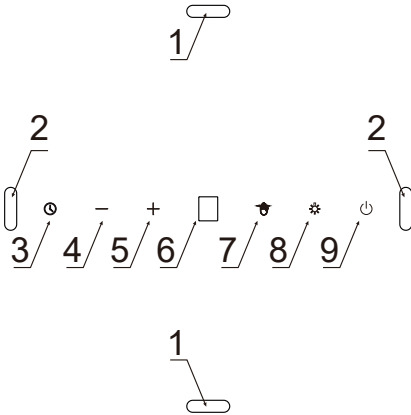

1-Gesture sensors for switching the light on/off.

2-Gesture sensors for fan speed control.

The control panel is equipped with touch controls: Control functions are described below:

3-Off-Timer sensor

4-Reduce fan speed sensor

5-Increase fan speed sensor



6-Display

7-Gesture control management sensor

8-Light control sensor

9-StandBy mode sensor

(Figure 1)

When you plug in your appliance, **8** will be shown on the display for a fraction of a second, then the display will go off. Only the  gesture control sensor is illuminated on the control panel. Touch  to activate the appliance — the  pictogram will light up.



When activated, touch **+** to start the fan.

Available fan speeds:

- Low speed(1). Use this speed when cooking a little food with hardly any fumes.
- Medium speeds(2-3). Use this speed when cooking multiple dishes at the same time with moderate amount of fumes.
- Turbo(). Use this speed when frying or grilling with large amount of fumes.

Use the + and - sensors to increase or reduce fan speed.

Note: The turbo speed is active only for 5 minutes(the dot on the display flashes), then the fan speed will be reduced. Turbo speed operation is time limited. By activating the turbo speed again and again, you can use it for a maximum of 30 minutes(including the turbo off intervals if shorter than 5 minutes). After this time, turbo speed will not be available for the next 30 minutes-during this time, the maximum possible fan speed is 3.

To turn off the fan, touch—repeatedly until fan speed is reduced to zero , or touch .



Touch  sensor to turn bottom lighting on.



Touch  sensor again, decorative lighting turns on, bottom lighting will off.





Touch  sensor third time, lighting will turn off.

Touch and hold  sensor for 2 seconds, all lightings will turn on, bottom and decorative.



Off-Timer

Use Off-Timer to turn off the hood after a specified time. Use Off-Timer to filter the fumes out of the air after cooking. The Off-Timer can be set to 5, 10 or 15 minutes. Touch  to activate the Off-Timer at any time. The sensor will flash and the display will show . Now use the - and + sensors to select the Off-Timer delay:

Display indication	Delay time [min]
	15
	10
	5

Touch  to confirm your Off-Timer setting(according to the above table). A flashing dot will appear by the fan speed on the display and the  sensor will flash. Touch  to deactivate the Off-Timer at any time—the dot by the fan speed and  will stop flashing.

Gesture control

When you plug in your appliance gesture control is active and  indicator is on. Touch  to turn off the gesture control. Touch  again to reactivate gesture control.

You can use gestures to control the fan speed and lighting. When gesture

control is active, you can also control the appliance using the touch sensors.

Gesture control works correctly when you move your open hand about 5cm from the surface of the control panel.

Note: Depending on the function you want to activate you need to move your hand near the sensors (Figure 1, item 1, or Figure 1, item 2). The area over which to move your hand is marked on the figures presented below in this manual.

When activating a certain function (such as turbo speed) requires multiple hand gestures, reposition your hand for another gesture away from the control panel to avoid triggering the motion sensors). Hand movements must not be too fast. Preferably, a single gesture should take about 1 second.

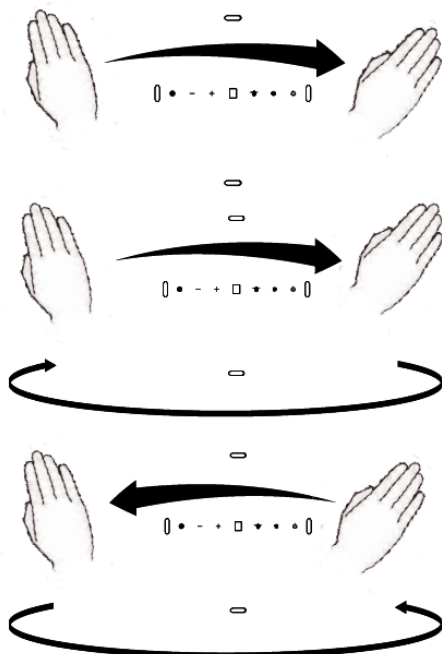

To activate the appliance move your hand from left to right. The display will show .

To turn on the fan or increase fan speed, move your hand from left to right several times in standby mode. The display will show the current fan speed after each hand gesture.

To turn off the fan or reduce fan speed, move your hand from right to left several times in standby mode until the display shows . Move your hand one more time and the appliance will turn off (gesture control will still be active).

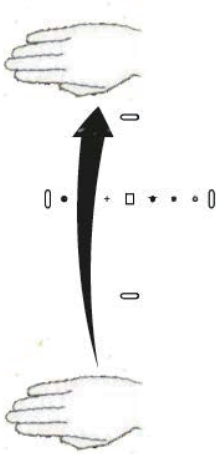

Move your hand from the bottom up to turn on the lighting. Move your hand from the bottom up once more, the decorative lighting will also turn on.

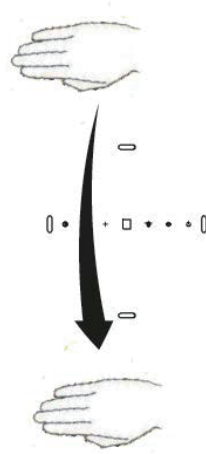

Move your hand from the top to bottom to turn off the lighting.

Grease Filters

The grease filters should be cleaned frequently. Use a warm detergent solution. Grease filters are washable.

See "INSTALL FILTERS" section for removal and installation instructions.

Non-Ducted Recirculation charcoal filter

The non-ducted recirculation charcoal filter should be changed every 6 months.

See "INSTALL FILTERS" section for removal and installation instructions.

INSTALL THE DUCTWORK

(DUCTED HOODS ONLY)

Caution: To reduce the risk of fire, use metal ductwork is preferred.

1. Decide where the ductwork will run between the hood and the outside.
2. A straight, short duct run will allow the hood to perform most efficiently.

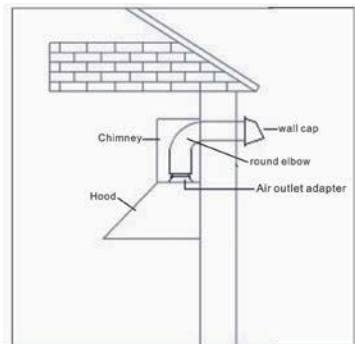

3. Long duct runs, elbows, and transitions will reduce the performance of the hood. Use as few of them as possible. Larger ducting may be required for best performance with longer duct runs.
4. The air must not be discharge into a flue that is used for exhausting fumes from appliances burning gas or other fuels" "Regulations concerning the discharge of air have to be fulfilled.
5. Install wall cap. Connect round metal ductwork to cap and work back towards hood location. Use duct tape to seal the joints between ductwork sections.

INSTALL ELECTRICAL

Electrical wiring must be done by a qualified person(s) in accordance with all applicable codes and standards. This range hood must be properly grounded. Turn off electrical power at service entrance before wiring.

If the supply cord is damaged, it must be replaced by the manufacturer, its service agent or similarly qualified persons in order to avoid a hazard.

INSTALL THE HOOD

Note 1 : On stainless steel hoods, carefully remove the plastic protective film from all exterior surfaces of the hood and chimney prior to final installation.

Note 2: At least two people will be required to mount the hood.

INSTALL THE HOOD

Minimum hood distance above cooker must not be less than 650mm.

A maximum of 750mm above the cooker is highly recommended for best capture of cooking impurities.

Distance over 750mm above the cooker are at the installer’s and user’s discretion - providing that ceiling height and flue length permit.



1. Secure the hood mounting bracket to the wall using (3) ST 5 x 45mm mounting screws and dry wall anchors. Secure the chimney mounting bracket to the wall using (2) ST 4.2 x 30mm mounting screws and dry wall anchors.

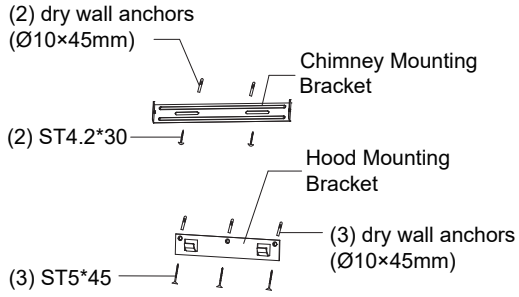

2. Fix the discharge collar into the air outlet adapter.

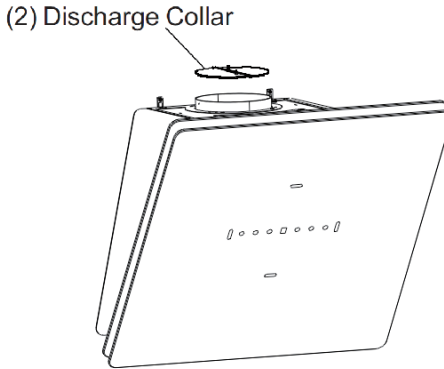

3. Attach an adequate length of 150mm round duct to the air outlet adapter(if have).

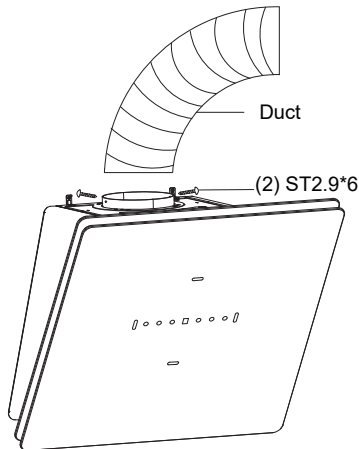

- Align the hood body with the hood mounting bracket. Gently lower the hood until it securely engages the bracket.

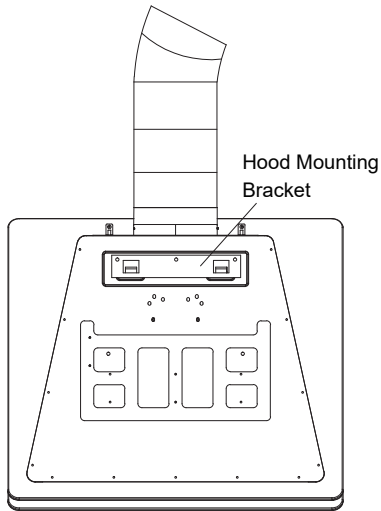

- Carefully place the decorative chimney bottom into the recessed area of the hood body top. Secure the decorative chimney bottom to the wall using (2) ST 2.9 x 14mm mounting screws and dry wall anchors.

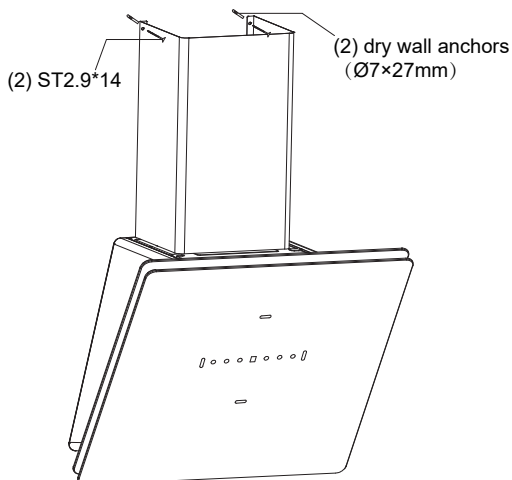

6. Carefully slide the decorative chimney top down inside the decorative chimney bottom. Raise the decorative chimney top until its holes align with holes in the chimney mounting bracket (located on the wall). Secure the chimney with 2 screws M4*6mm.

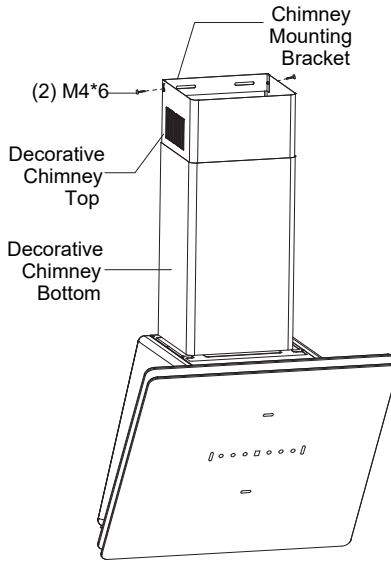

7. Fix the range hood with screws (2) ST4.2*30mm and dry wall anchors from inside of body.

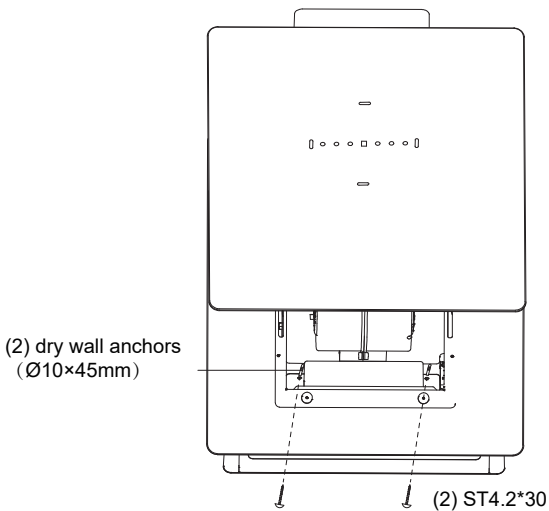

INSTALL FILTERS

1. To remove the grease filter, push in on the latch. This will disengage the filter from the hood. Tilt the filter downward and remove.
2. To install the grease filter, align rear filter tabs with slots in the hood. Push in the latch, push filter into position and release. Make sure the filter is securely engaged after assembly.

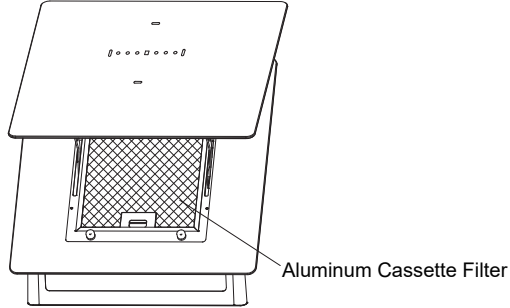

3. To install the charcoal filter , secure the charcoal filter to the left side of motor housing by turning anticlockwise, secure the charcoal filter to the right side of motor housing by turning clockwise.

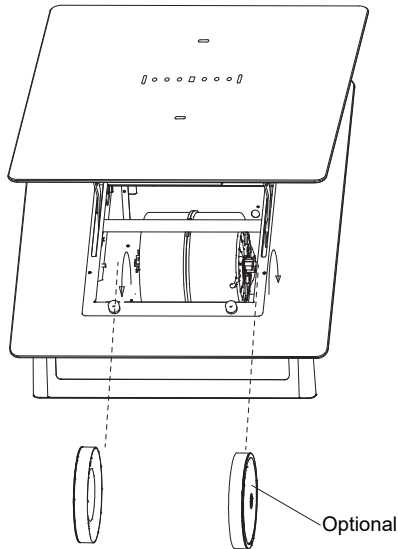

4. Install grease filter after charcoal filter is installed.

HOOD CLEANING

Stainless steel is one of the easiest parts to keep clean. Occasional care will help preserve its fine appearance.

Cleaning tips:

- * Hot water with soap or detergent is all that is usually needed.
- * Follow all cleaning by rinsing with clear water. Wipe dry with a clean, soft cloth to avoid water marks.
- * For discolorations or deposits that persist, use a non-scratching household cleanser or stainless steel polishing powder with a little water and a soft cloth.
- * For stubborn cases use a plastic scouring pad or soft bristle brush together with cleanser and water. Rub lightly in direction of polishing lines or "grain" of the stainless finish. Avoid using too much pressure that may mar the surface.
- * Do not allow deposits to remain for long periods of time.
- * Do not use ordinary steel wool or steel brushes. Small bits of steel may adhere to the surface causing rust.
- * Do not allow salt solutions, disinfectants, bleaches, or cleaning compounds to remain in contact with stainless steel for extended periods. Many of these compounds contain chemicals that may be harmful. Rinse with water after exposure and wipe dry with a clean cloth.
- * Painted surfaces should be cleaned with warm water and mild detergent only.

MALLOCA VIETNAM COMPANY LIMITED

Showroom:

279 Nguyen Van Troi Street, Ward 10, Phu Nhuan District, HCM City

Tel: (84) 28 39975 893 / 94

Fax: (84) 28 38447 102 - (84) 28 38633 882

Email: info@malloca.com

Customer Care:

Hotline: 1800 12 12

Email: chamsockh@malloca.com

CÔNG TY TNHH MALLOCA VIỆT NAM

Showroom:

279 Đường Nguyễn Văn Trỗi, Phường 10, Quận Phú Nhuận, TP.HCM

Điện Thoại: (84) 28 39975 893 / 94

Fax: (84) 28 38447 102 - (84) 28 38633 882

Email: info@malloca.com

Hệ thống chăm sóc khách hàng:

Hotline: 1800 12 12

Email: chamsockh@malloca.com

Trung tâm chính

279 Đường Nguyễn Văn Trỗi, Phường 10, Quận Phú Nhuận, TP.HCM

SĐT: (028) 39975 893 / 94 – (028) 39975 294 / 95

Khu vực Bà Rịa Vũng Tàu

258-260A Lê Hồng Phong, Phường 4, TP. Vũng Tàu

SĐT: (0254) 385 94 99

Khu vực Tây Nguyên

331 Phan Đình Phùng, Phường 2, TP. Đà Lạt

SĐT: (0263) 3521 107 – 0918226362

Khu vực Nam Trung Bộ

08 Lê Hồng Phong, Phường Phước Hải, TP. Nha Trang

SĐT: (0258) 3875 488

Khu vực Miền Tây

180 Trần Hưng Đạo, Phường An Nghiệp, Quận Ninh Kiều, TP. Cần Thơ

SĐT: (0292) 373 2035

Khu vực Miền Trung

211 Nguyễn Văn Linh, Phường Vĩnh Trung, Quận Thanh Khê, TP. Đà Nẵng

SĐT: (0236) 369 1906

Khu vực Miền Bắc

10 Chương Dương Độ, Phường Chương Dương, Quận Hoàn Kiếm, Hà Nội

SĐT: (024) 35376 288 – 093 462 92 98

