

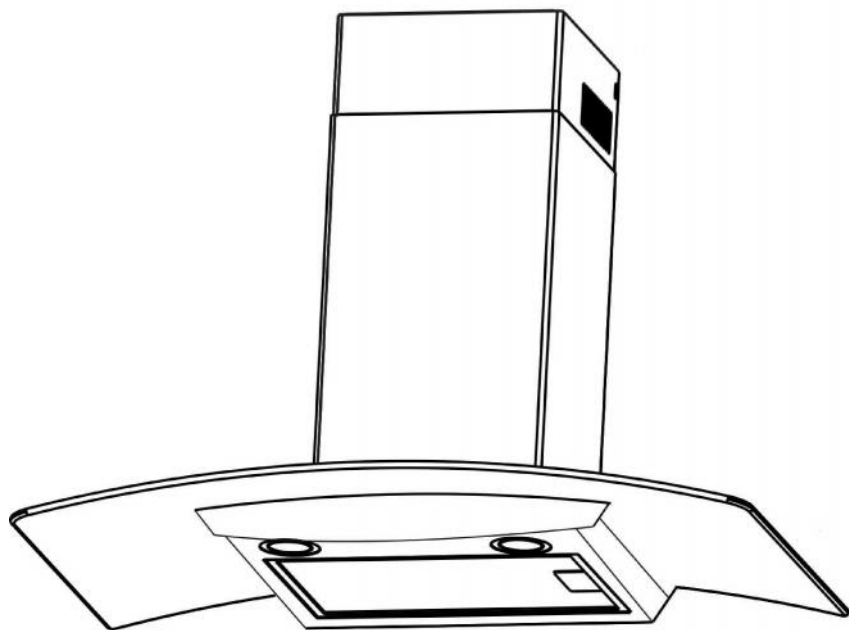

## **COOKER HOOD**

### **INSTRUCTION MANUAL**



**Model No: MC 1070 - MC 1090**

Dear Customer,

If you follow the recommendations contained in this Instruction Manual, our appliance will give you constant high performance and will remain efficient for many years to come.

## **CONTENTS**

---

### **RECOMMENDATIONS AND SUGGESTIONS CHARACTERISTICS INSTALLATION & USE MAINTENANCE**

#### **RECOMMENDATIONS AND SUGGESTIONS**

---

##### **INSTALLATION**

- \* The manufacturer will not be held liable for any damages resulting from incorrect or improper installation.
- \* Please read this instruction manual before installing and using this cooker hood. Properly keep this instruction manual in a safe place for future reference.
- \* This cooker hood can be used either in the Ducted Mode (ducting fumes to the outside) or in the Recirculation Mode (internal recycling). The choice of modes can be left to customers.
- \* Only a qualified and trained service technician can undertake the work of installation and servicing.
- \* Check that the mains voltage corresponds to the one indicated on the rating plate fixed inside the hood.
- \* Check that the domestic power supply guarantees adequate earthing.
- \* Do not connect the hood to exhaust ducts carrying combustion fumes (boilers, fireplaces, etc.)
- \* If the hood is used in conjunction with non-electrical appliances (e. g. gas burning appliances), a sufficient degree of aeration must be guaranteed in the room in order to prevent the backflow of exhaust gas. The kitchen must have an opening directly with the open air in order to guarantee the entry of clean air.

\* The minimum distance is 750mm from the cooker hood to a gas hob, and is 650mm to an electric hob. If the installation instructions for gas hobs specify a greater distance, this must be taken into account.

**NOTICE:** Considering excessive weight, two or more people are required to install or move this appliance. Failure to do so can cause physical injuries.

## **USE**

\* The cooker hood has been designed only for domestic use to eliminate kitchen fumes.

\* Never use the hood for purposes other than what it has been designed for.

\* Never leave high naked flames under the hood when it is in operation.

\* Adjust the flame intensity to direct it onto the bottom of the pan only; making sure that it does not engulf the pan sides.

\* Deep fat fryer must be continuously monitored during use: overheated oil can burst into flame.

\* The hood should not be used by children or person not instructed in its correct use.

## **MAINTENANCE**

\* Proper maintenance of the Range Hood will assure proper performance of the unit.

\* Disconnect the hood from the main supply before carrying out any maintenance work.

\* Clean and/or replace aluminum grease filters and activated charcoal filters after specified period of time.

\* Clean the hood using a damp cloth and a neutral liquid detergent.

\* **DISPOSAL:** Do not dispose this product as unsorted municipal waste. Collection of such waste separately for special treatment is necessary.

## **WARNING!!**

In certain circumstances electrical appliances may be a danger hazard.

\* Do not check the status of the filters while the cooker hood is operating.

\* Do not touch the light bulbs after appliance use.

\* Do not disconnect the appliance with wet hands.

\* Avoid free flame, as it is damaging for the filters and a fire hazard.

\* Constantly check food frying to avoid that the overheated oil may become a fire

hazard.

- \* Disconnect the electrical plug prior to any maintenance.
- \* Children don't recognize the risks of electrical appliances. Therefore use or keep the appliance only under supervision of adults and out of the reach from children.
- \* Don't use this product outdoor.
- \* This appliance is not intended for use by persons (including children) with reduced physical, sensory or mental capabilities, or lack of experience and knowledge, unless they have been given supervision or instruction concerning use of the appliance by a person responsible for their safety. Children should be supervised to ensure that they do not play with the appliance.
- \* There shall be adequate ventilation of the room when the range hood is used at the same time as appliances burning gas or other fuels.
- \* There is a fire risk if cleaning is not carried out in accordance with instructions.
- \* Do not flambé under the range hood.
- \* The discharge air must not be discharged into a flue which is used for exhausting fumes from appliances burning gas or other fuels.

## CHARACTERISTICS

---

### DIMENSIONS

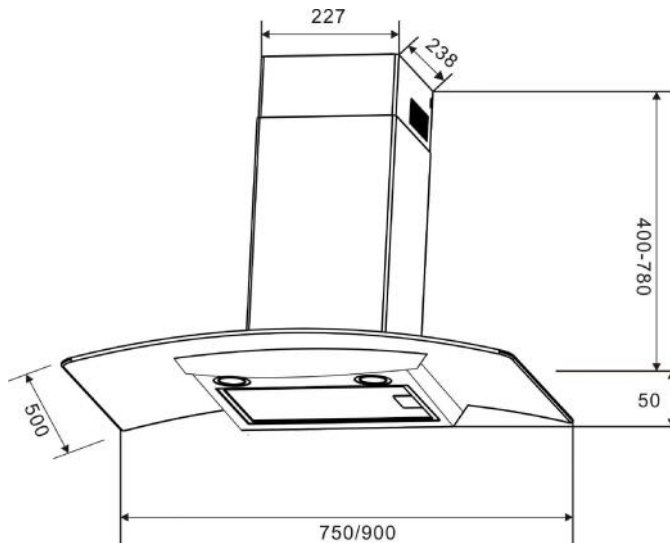

## **COMPONENTS**

<b>Ref</b>	<b>Q'ty</b>	<b>Product Components</b>
1	1pc	Hood body, complete with: controls, lights, blower, filters, air outlet adapter
2	1set	Telescopic Chimney comprising
2.1	1pc	Decorative Chimney Top
2.2	1pc	Decorative Chimney Bottom
3	1pc	Plastic Exhaust Duct
4	1pc	Glass
5	1pc	Charcoal Filter
6	1pc	Grease filter

<b>Ref</b>	<b>Q'ty</b>	<b>Installation Components</b>
7.1	1pc	Chimney Mounting Bracket
7.2	1pc	Hood Mounting Bracket
8	1set	Damper (flaps)
10.a	5pcs	Mounting Screws (ST 5 X 50MM)
10.b	2pcs	Chimney Mounting Bracket Screws (M 4 X 10 MM)
10.c	3pcs	Chimney Bottom Fixing Screws (ST 4 X8 MM)
11	5pcs	Drywall Anchors

<b>Ref</b>	<b>Q'ty</b>	<b>Documentations</b>
12	1pc	Instruction Manual

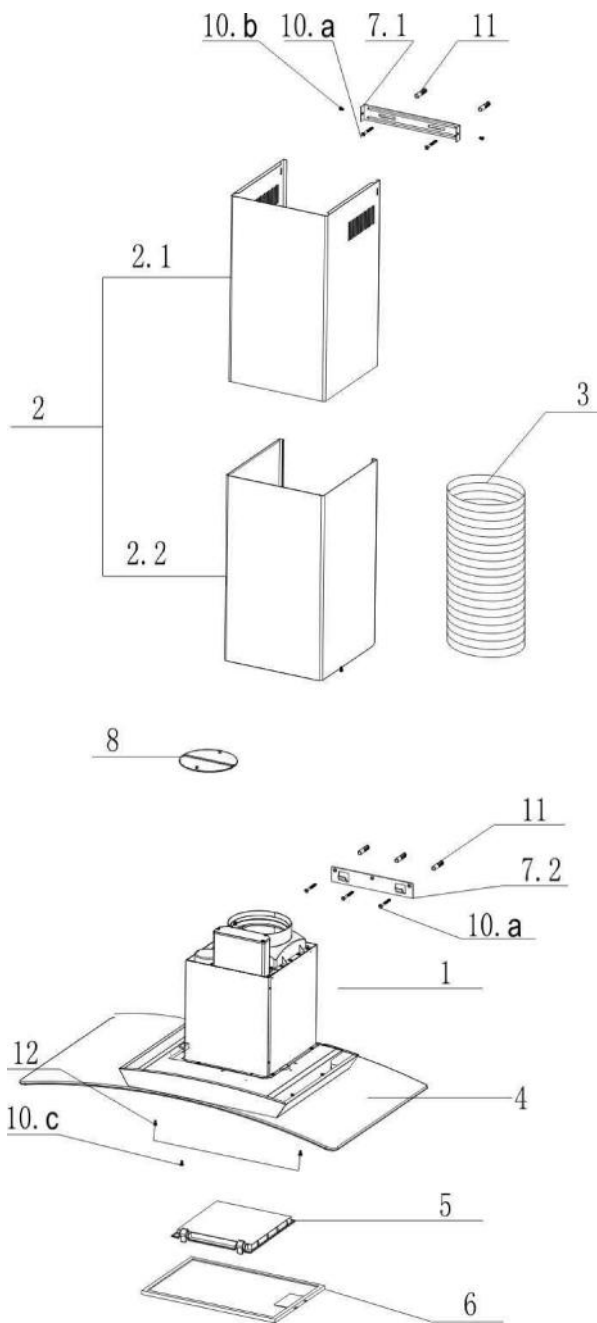

## INSTALLATION & USE

Note 1 : On stainless steel hoods, carefully remove the plastic protective film from all exterior surfaces of the hood and chimney prior to final installation.

Note 2: At least two people will be required to mount the hood.

### **WALL DRILLING AND BRACKETS FIXING (X=Y-256)**

1. Draw a vertical line on the supporting wall up to the ceiling, or as high as practical, at the centre of the area in which the hood will be installed.
2. Draw a horizontal line at 650mm above the electric hob or 750mm above the gas hob.
3. Place chimney mounting brackets 6.1 on the wall as shown about 20mm from the ceiling or upper limit aligning the centre (notch) with the vertical reference line.
4. Mark the wall at the centre of the holes in the bracket.
5. Place the hood mounting bracket 6.2 on the wall as shown aligning the central notches to the vertical reference line.
6. Mark the wall at the centre of the holes in the bracket.
7. Drill  $\phi$  10mm holes at all the centre points marked.
8. Fix the two brackets using the mounting screws and drywall anchors.

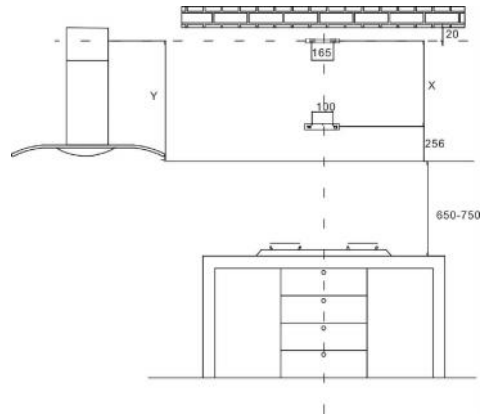

### **MOUNTING THE HOOD BODY**

1. Hook the body onto the hood mounting bracket 7.2 as shown.
2. Balance the hood body by slightly adjusting the hood mounting bracket. Gently lower the hood until it securely engages the bracket.

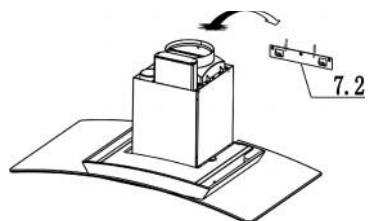

### **DAMPER (FLAPS) FIXING**

1. Fix the damper (flaps) into the air outlet adapter.
2. To be sure that the damper (flaps) is locked well on the air outlet adapter, it should be flexible in opening and closing.

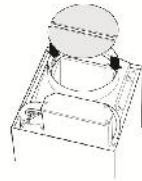

### **PCB CONTROL BOX FIXING**

1. Release two screws from the PCB control box fixing hole;
2. Fix the PCB control box by tighten the two screws. ■

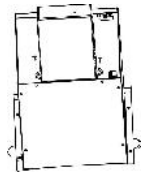

### **DUCT FIXING**

Caution: To reduce the risk of fire, use metal ductwork only.

1. Attach an adequate length of  $\phi$  150mm round duct into the recessed area of the air outlet adapter.
2. Secure the duct using two screws that have been already fixed on the two sides of the air outlet adapter. Make sure the duct is fixed well on.

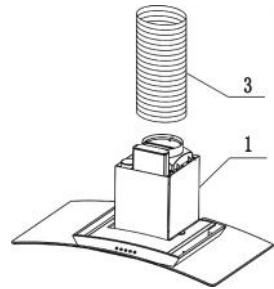

### **CONNECTIONS**

#### **Ducted mode air exhaust system**

Caution: To reduce the risk of fire, use metal ductwork is preferred.

1. Decide where the ductwork will run between the hood and the outside.
2. A straight, short duct run will allow the hood to perform most efficiently.
3. Long duct runs, elbows, and transitions will reduce the performance of the hood. Use as few of them as possible. Larger ducting may be required for best performance with longer duct runs.
4. Attach an adequate length of  $\phi$  150mm round duct to the air outlet adapter.
5. The air must not be discharge into a flue that is used for exhausting fumes from appliances burning gas or other fuels" "Regulations concerning the discharge of air have to be fulfilled.
6. Install a roof/wall cap. Connect round metal ductwork to cap and work back towards hood location. Use duct tape to seal the joints between

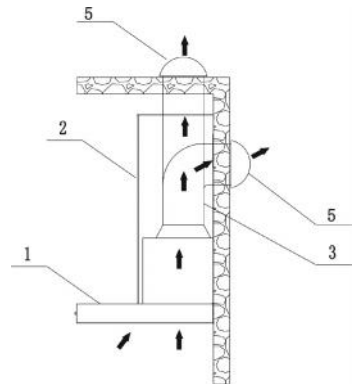



ductwork sections.

### Recirculation Mode

Caution: Do not use plastic or rigid metal ducting.

1. Determine the length of the compressed flexible aluminum ducting. Attach an adequate length of  $\phi$  150mm round duct to the air outlet adapter.
2. Install the charcoal filter on.
3. Please note that the air will flow out from the two grids on the sides of the decorative chimney top.

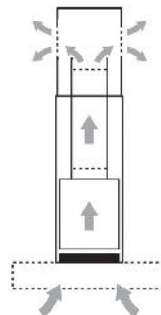

### Electrical Connection

\* Electrical wiring must be done by a qualified person(s) in accordance with all applicable codes and standards. **Turn off electrical power at service entrance before wiring.**

\* If the supply cord is damaged, it must be replaced by the manufacturer, its service agent or similarly qualified persons in order to avoid a hazard.

\* Do not use the plug and an extension cord other than the ones initially supplied with the hood.

\* The earthing of this hood is compulsory. Do not remove ground prong of the plug.

### TELESCOPIC CHIMNEY COMPRISING ASSEMBLY

#### Decorative Chimney Top

Raise the decorative chimney top 2.1 up inside the decorative chimney bottom 2.2. Secure decorative chimney top 2.1 to the

chimney mounting bracket that is well fixed on the wall with the two chimney bracket screws 10.b supplied from two sides.

#### Decorative Chimney Bottom

1. Carefully slide the decorative chimney bottom 2.2 down outside the decorative chimney top 2.1. Carefully place the decorative chimney bottom 2.2 into the recessed area of the hood body top.
2. Fix the Decorative Chimney Bottom 2.2 with the three decorative Chimney Bottom screws 10.c supplied from inside of hood body.

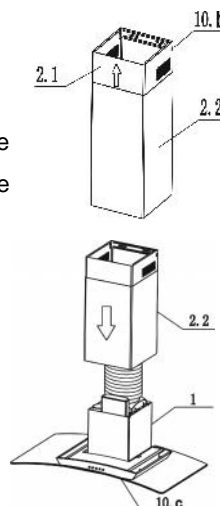

## SOFT TOUCH CONTROL SWITCH

The hoods may be operated using the soft touch control on the front panel.

The lights switch turns the lamps on and off.

The blower switch turns the blower on to three speed settings:

1 –Lamp





2 - PLUS

3 - MINUS



4 – ON/OFF





### How to set the clock



Press button  for 3 seconds, the time indicator in the display keep flashing, press button  and  to adjust hour setting, push button  again to set the minute setting. The machine will automatically confirm if without any operation in 3 seconds.

### How to set timer delay

When the fan is working, press button  for 3 seconds, light the timer delay indicator in the display and time indicator keep flashing, Press button  and  to set the delay time range from 1min to 15mins. The machine will automatically confirm the setting if without any operation in 3 seconds.

### Clean indicator function

After long time usage, If the symbol  in the display light, that indicates the grease filter reach saturation and need to wash. Keep pressing the  for 3 seconds to remove this symbol if the filter have been cleaned.

**Note:** The symbol  will keep lighting if without operation of keeping button  for 3 seconds

## MAINTENANCE

### GREASE FILTER

\* The grease filters should be cleaned frequently (every two months of operation, or more frequently for heavy use). Use a warm detergent solution.

\* Grease filters are washable.

1. Remove the grease filter one by one by pulling out each latch. This will disengage the filter from the hood. Tilt the filter downward and remove.
2. Wash the filters, taking care not to bend them. Allow them to be dry before refitting.
3. When refitting the filters, make sure that the handle is visible from the outside.
4. To install the grease filter, align rear filter tabs with slots in the hood. Pull out the latch, push filter into position and release. Make sure the filter is securely engaged after assembly.

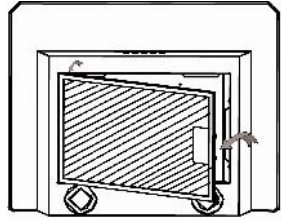

### **NON-DUCTED RECIRCULATION CHARCOAL FILTER**

This filter is not washable, can not be regenerated, and should be replaced approximately every 3 months of operation, or more frequently in the case of heavy usage.

1. To install the charcoal filter, and lock it until the stop click is heard.
2. Install grease filter after charcoal filter is installed.

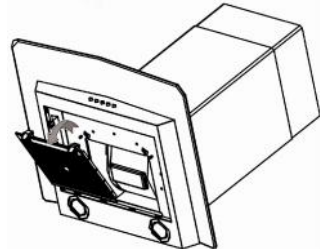

### **LED LAMPS**

This range hood may require two LED lamps (DC12V, 2W Max)

**WARNING:** Always switch off the electrical supply before carrying out any operation on the appliance.

To change bulbs:

1. Kick off the LED cover ② by using the flat screw driver.
2. Disconnect the lamp terminal.
3. Replace with Type DC12V, 2W Max, halogen bulb. Do

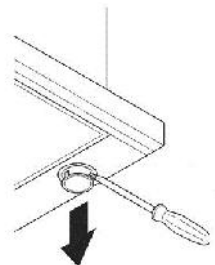

not touch replacement bulb with bare hands !

### **CAUTION:**

1. THE SURFACE, THE COVER OF THE LED BULBS MAY BE HOT. TAKE CARE WHEN TAKING THE REPLACEMENT.
2. BULBS MAY BE HOT. TAKE CARE WHEN TAKING THE REPLACEMENT.
- 3.

### **OIL CUP**

1. To install the oil cup, and lock it on to the motor blower.
2. The oil cup should be cleaned frequently. The oil accumulated inside the oil cup can not be more than half. Use a warm detergent solution.
3. Allow it to be dry before refitting.

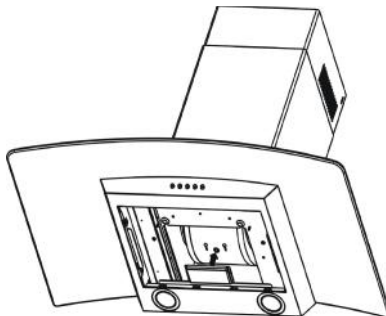

### **HOOD CLEANING**

Stainless steel is one of the easiest materials to keep clean. Occasional care will help preserve its fine appearance.

Cleaning tips:

- \* Hot water with soap or detergent is all that is usually needed.
- \* Follow all cleaning by rinsing with clear water. Wipe dry with a clean, soft cloth to avoid water marks.
- \* For discolorations or deposits that persist, use a non-scratching household cleanser or stainless steel polishing powder with a little water and a soft cloth.
- \* For stubborn cases use a plastic scouring pad or soft bristle brush together with cleanser and water. Rub lightly in direction of polishing lines or “grain” of the stainless finish. Avoid using too much pressure that may mar the surface.
- \* Do not allow deposits to remain for long periods of time.
- \* Do not use ordinary steel wool or steel brushes. Small bits of steel may adhere to the surface causing rust.
- \* Do not allow salt solutions, disinfectants, bleaches, or cleaning compounds to remain in contact with stainless steel for extended periods. Many of these compounds contain chemicals that may be harmful. Rinse with water after exposure and wipe dry with a clean cloth.
- \* Painted surfaces should be cleaned with warm water and mild detergent only.

